

DACIA DUSTER



TO US, REAL PEOPLE

All-New Dacia Duster goes further: more robust, more outdoor, more technology both inside and out. It allows you to go anywhere, thanks to its connectivity, its 4x4 performance, and its new equipment. With the new hybrid version, it is also more eco-smart than ever.



**FULL HYBRID
140 HP ENGINE**

**4X4 VERSION WITH A
NEW MODE SELECTOR**

**10" CONNECTED
TOUCH SCREEN***

**UP TO 5 YOUCLIP
ATTACHMENT POINTS****

*From Expression. **3 on Essential, 5 from Expression.

INTERACTIVE MENU

01. DESIGN

02. DRIVING PLEASURE

03. CONNECTIVITY

04. SPACIOUSNESS

05. DRIVING AIDS

**06. SPECIAL TECHNICAL
FEATURES**

THE REDESIGNED ICONIC SUV

All-New Dacia Duster continues its success story and increases its versatility with its iconic design and its excellent off-road capabilities. Its Starkle[®] side protectors and wheel arches showcase its powerful SUV nature. Bursting with practicality for all your adventures, All New Duster comes with roof bars as standard. Chose the Extreme trim and these become Dacia's clever modular design allowing each switching from lengthways to crossways.

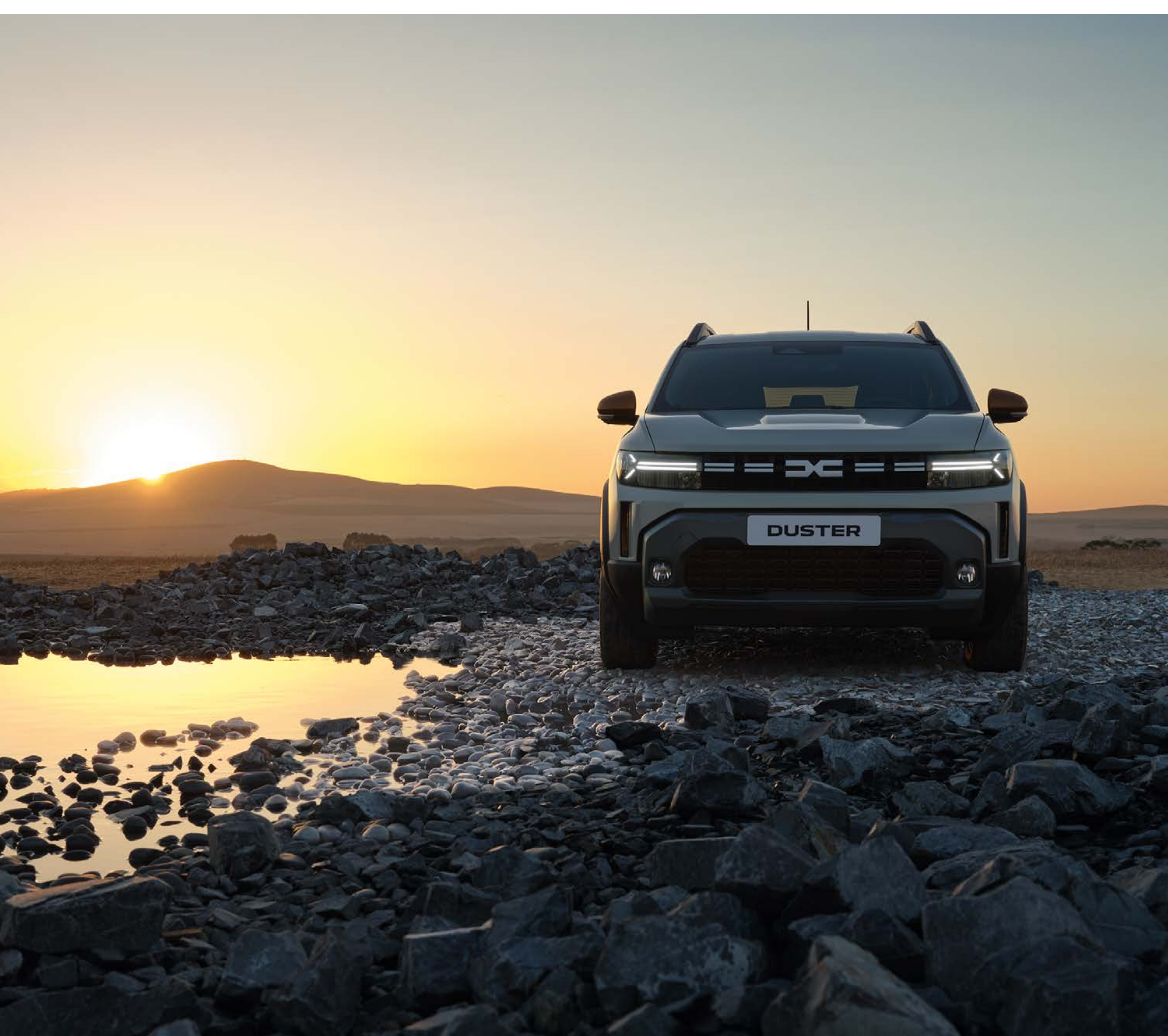

Y-shaped brand light



* Copper door mirrors (standard on Extreme versions)

NEW INTERIOR EXPERIENCE

For the interior of its flagship, Dacia has focused on ergonomics, design, and your well-being on board. The driver has a carefully oriented 10" central* display for easy access. The 7" digital cluster* keeps driving information in sight.

* available from Expression



The new steering wheel design makes driving more comfortable. In terms of styling, the new Y-shaped headlight graphics are seen on the door panels as well as air vents.



In Extreme version, washable MicroCloud plastic-coated fabric upholstery

[CONFIGURE AND ORDER](#)

[MENU](#) ^

AVAILABLE IN HYBRID

For the first time, All-New Dacia Duster comes equipped with a full hybrid 140 engine. Enjoy a more dynamic version with no charging constraints. You will be able to drive up to 80 % in fully electric mode in an urban environment and reduce your fuel consumption by up to 40 %*. This hybrid engine is coupled to an innovative clutchless automatic gearbox that makes driving even more comfortable.



All-New Duster is also available with TCe 100 Bi-Fuel Engines, as well as TCe 130 petrol 4x2 and 4x4 versions assisted by a mild hybrid system to optimise fuel consumption in the most energy-intensive driving phases.

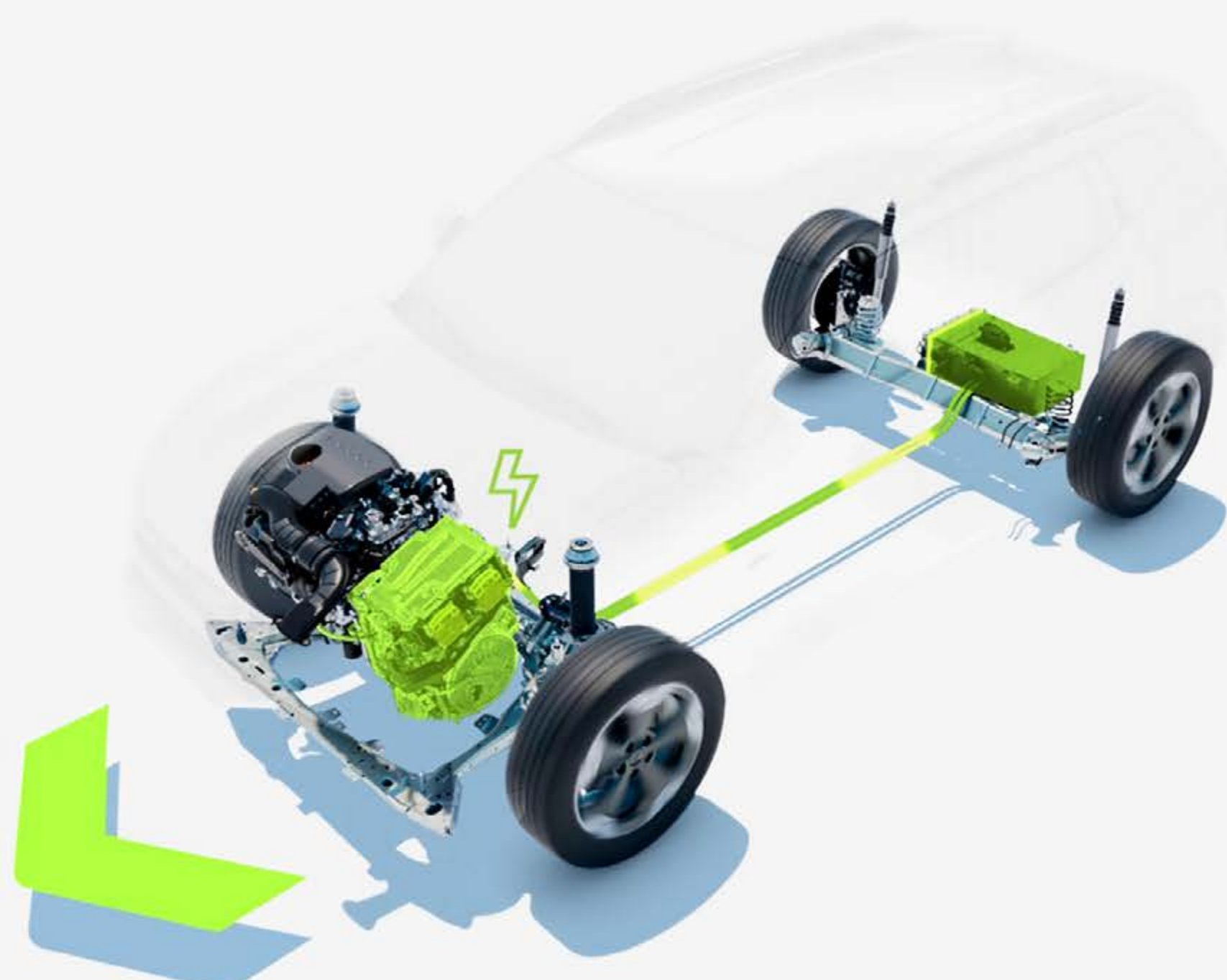

The battery recharges during braking and deceleration.

* Driving in urban environments, compared with an equivalent internal combustion engine.

A TRUE OFF-ROAD VEHICLE

In its 4x4 version, All-New Duster will enable you to tackle all situations quickly with its new driving mode selector. With a high ground clearance of up to 217 mm, an approach angle of up to 31° for climbing slopes in 4x4 mode, Starkle® anti-scratch materials: All New Duster is ready for adventure on the road and off the beaten track.



You can always control your vehicle's angle via the "all road info" menu on the 10" central touch screen* computer and through the direct access to the multiview camera**.

* 10" touch screen available from expression

** Multiview camera available from Journey version



Touchscreen with 4x4 information: slope angles and power per axle



Driving mode selection button

* on 4x4 versions only.

[CONFIGURE AND ORDER](#)

[MENU](#) ^

A More Digital and Connected On-board experience

All-New Dacia Duster makes your daily life easier with the new Media Nav Live multimedia system*. On its large 10" central touchscreen, you can easily access to the real time traffic navigation with up-to-date maps**. Enjoy the wireless smartphone replication for both Android Auto™ and Apple CarPlay™ to make your journeys easier. You can also benefit from practical connected services such as remote vehicle location or the display of the milage information through your MY Dacia app. You can also benefit from the new 3D sound system developed by Arkamys® 6 speakers that will bring out the best in your favourite tunes.



Duster's Essential version, comes with a multimedia system that can be controlled from your smartphone. This multimedia system includes : digital radio, 4 speakers, Bluetooth®, steering wheel controls and voice recognition. To go even further, download the new Media Control smartphone app.



* Available from Journey

** Included and updated for 8 years.

Android Auto™ is a trademark of Google Inc. Apple CarPlay™ is trademark of Apple Inc.

[CONFIGURE AND ORDER](#)

[MENU](#) ^

NEW YOUCLIP ATTACHMENT SYSTEM

With the New YouClip attachment systems, designed to organise your interior with a wide variety of accessories developed for the YouClip range. These can be easily clipped on the 5* attachments points, which are distributed throughout well-chosen places in the car including the boot. 2 additional points behind the headrests, available as accessories, extend the system to give you a maximum of 7 YouClip points. These additional points are perfect for your tablets or phones, with our multimedia tablet holder or our smartphone induction charger. For even more comfort, a stunning 3-in-1 YouClip accessory combines a cup holder, lamp and hook, which can be detached and used separately wherever needed.

* 3 points on Essential



The YouClip range offers several other new accessories, including a YouClip smartphone holder or a YouClip bag, practical for organising on-board activities.



YouClip - multimedia tablet holder



YouClip - hook

FOR ALL YOUR SPACE NEEDS

Enjoy the roominess with a spacious interior space, cleverly designed for your comfort and that of your passengers. Whatever your requirements, its modular design makes it perfectly versatile.

The generously roomy interior features plenty of rear legroom, a boot with a maximum capacity of 517 litres VDA and a flat floor.



Even more space with the adjustable roof bars to take everything you want.



longitudinal roof bars - from Essential Modular only on Extreme

OUTDOOR PERSPECTIVES WITH THE InNature RANGE

Travelling is unique with All-New Duster. Enjoy comfortable nights in the countryside with the Sleep Pack from the InNature accessories range and its removable double bed, 1.90 m long by 1.30 m wide. It can be set up by one person in less than two minutes, and comes with a retractable table at the rear for your breakfasts, as well as generous storage space of 160 litres in the hybrid version and 175 litres for the other engines.



Don't forget the blackout blinds sold as accessories to block out light and glare.

For a more spacious base camp, the Dacia hatchback tent connects to your Duster when the boot is open, creating 10 m² of protected sleeping space for up to 3 more people at the rear of the vehicle.

Freedom also means being able to take everything you need. Choose Dacia's exclusive InNature roof rack. It can be easily attached using our modular roof bars in traverse position, or to the transversal roof bars that are available as an accessory and accept a load of up to 80 kg.



Opaque blackout blinds



Dacia tailgate tent (up to 3 people in the bedroom area)



Roof rack

DRIVE IN COMPLETE SAFETY

In order to complete the range of equipment already present on board for your safety and your driving comfort, All-New Dacia Duster is equipped with new-generation driving aids. Using the My Safety button you can disable some of these aids at any time. Every journey with Dacia is a worry-free experience.

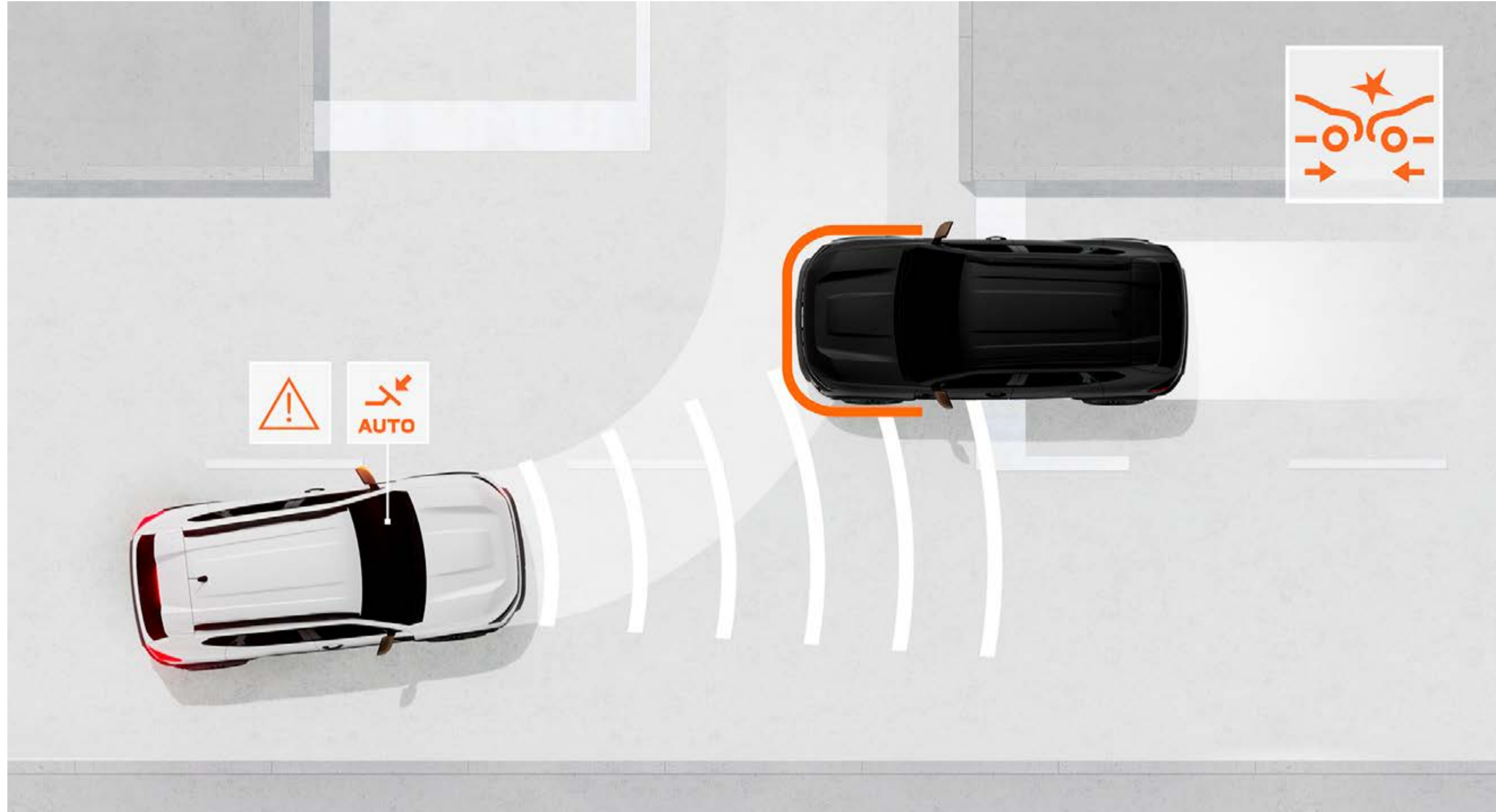

ACTIVE EMERGENCY BRAKING (AEBS)

This system prevents the risk of frontal collisions involving other vehicles, pedestrians or cyclists straight ahead and at junctions. It alerts the driver and can automatically brake the vehicle if necessary.

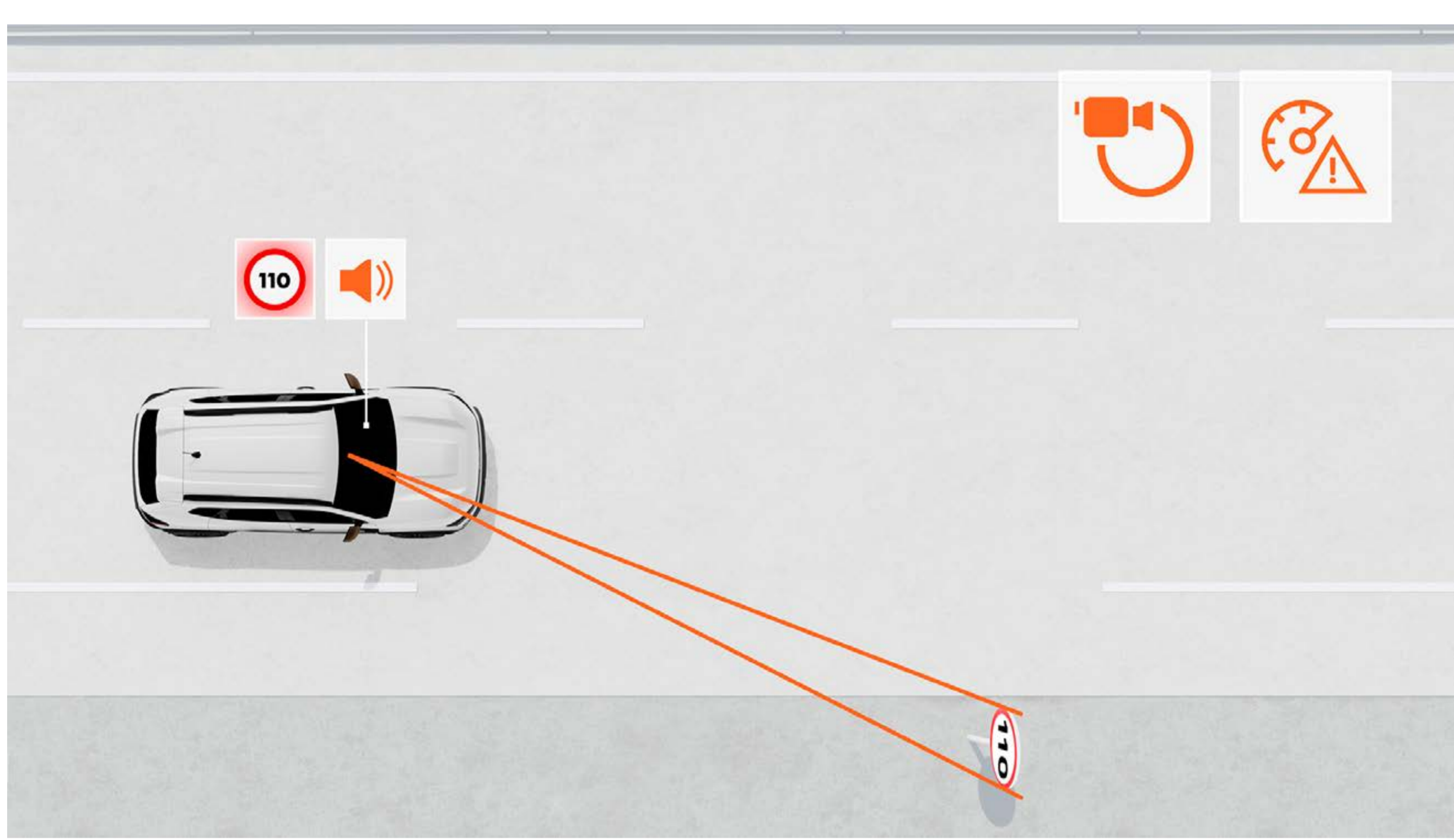

TRAFFIC SIGN RECOGNITION WITH SPEED ALERT

This system provides a reliable real-time indication of the maximum speed on the road and warns the driver if they exceed the speed limit with visual and audible alerts (which can be disabled).

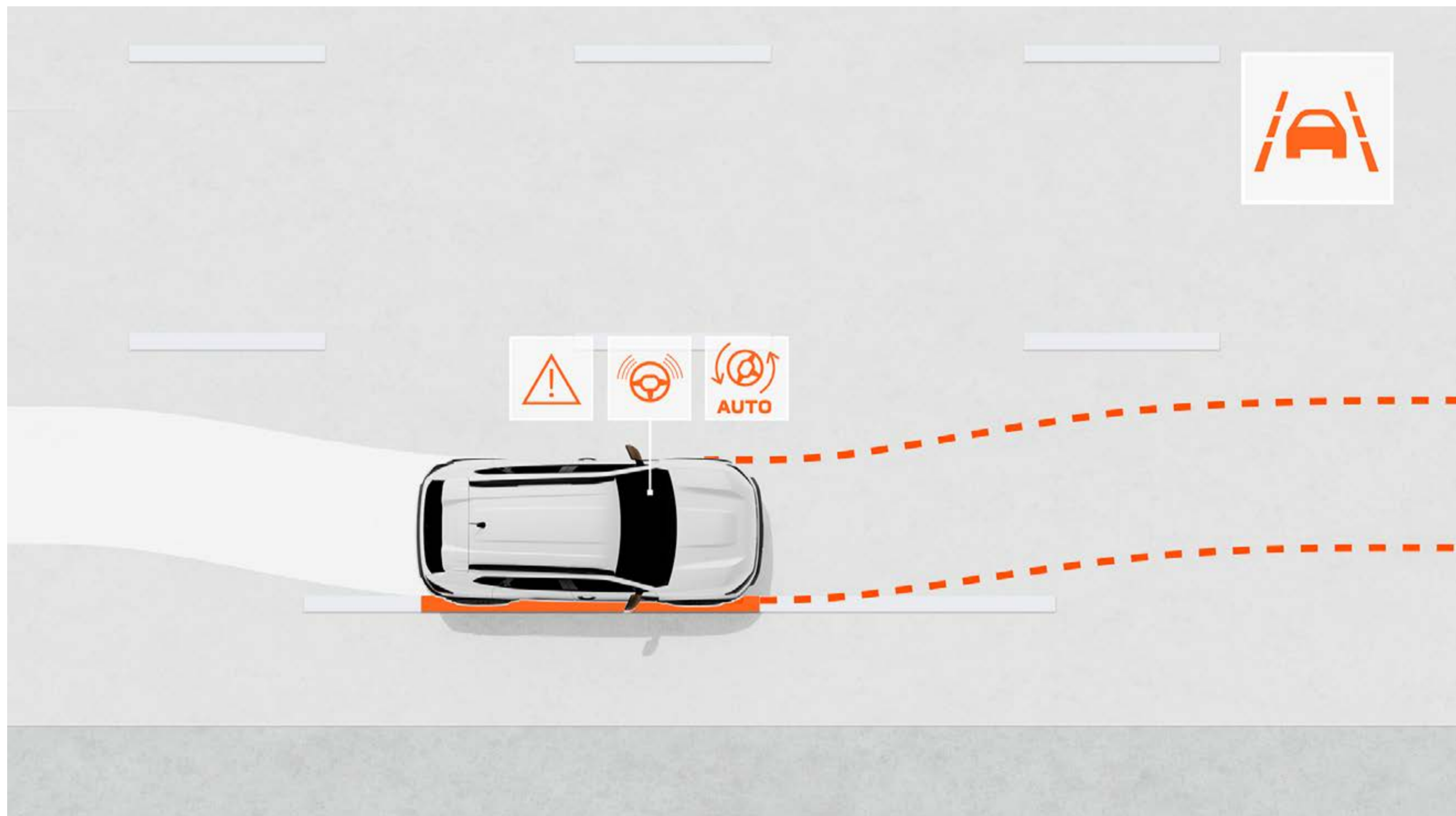

LANE KEEPING ASSIST AND LANE DEPARTURE WARNING

This aid monitors the vehicle's path in its lane and warns the driver if it unintentionally crosses a white line. If necessary, it can also correct the vehicle's trajectory with an automatic steering action.

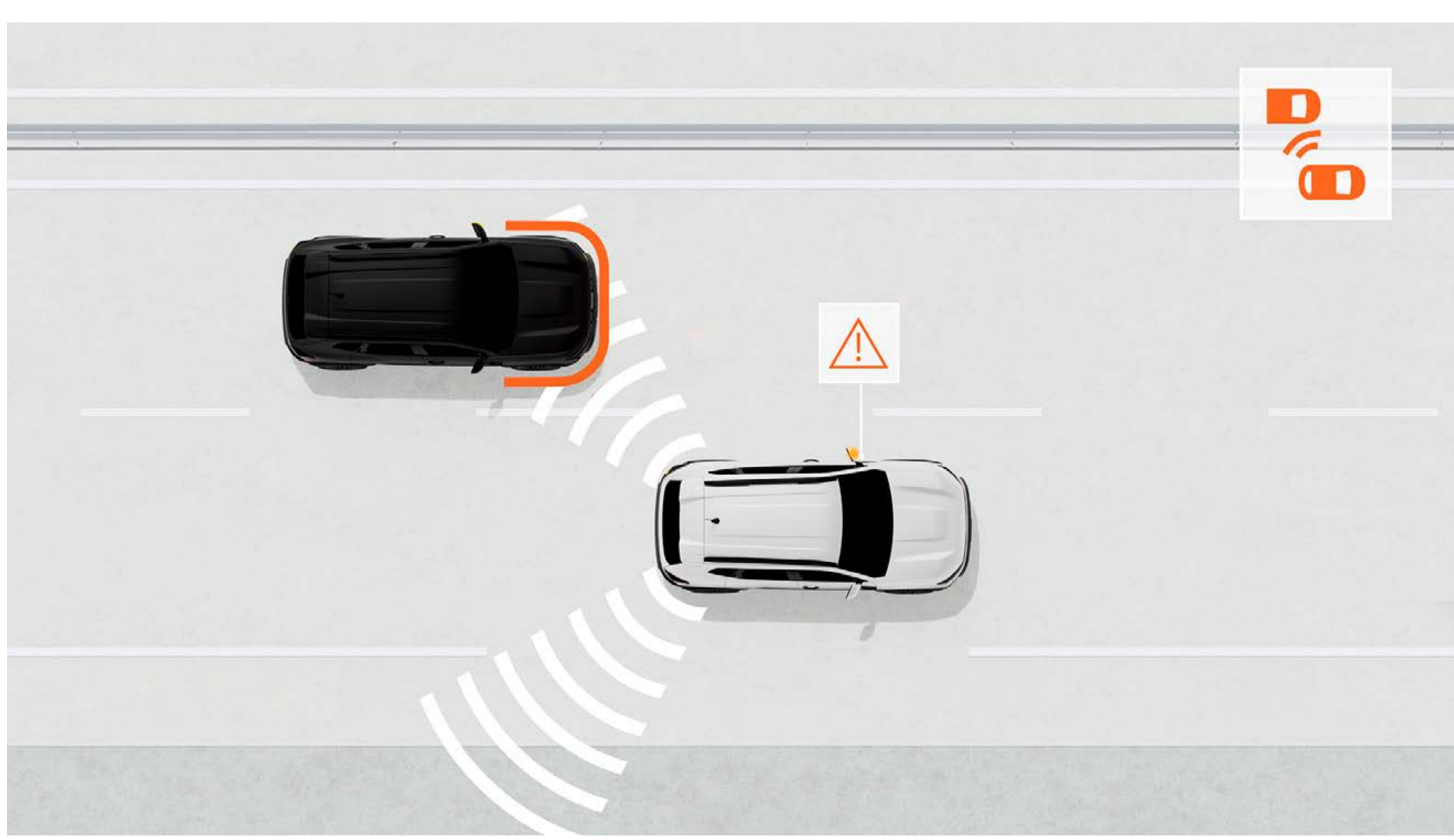

BLIND SPOT WARNING

This aid monitors the driver's areas of restricted vision to warn them with a visual signal if another vehicle or road user is in the area, allowing them to make lane changes safely.

* A only available on Journey and Extreme



HILL DESCENT SPEED MONITORING

In steep descents, this system limits the speed taken by the vehicle without having to use the brake pedal.

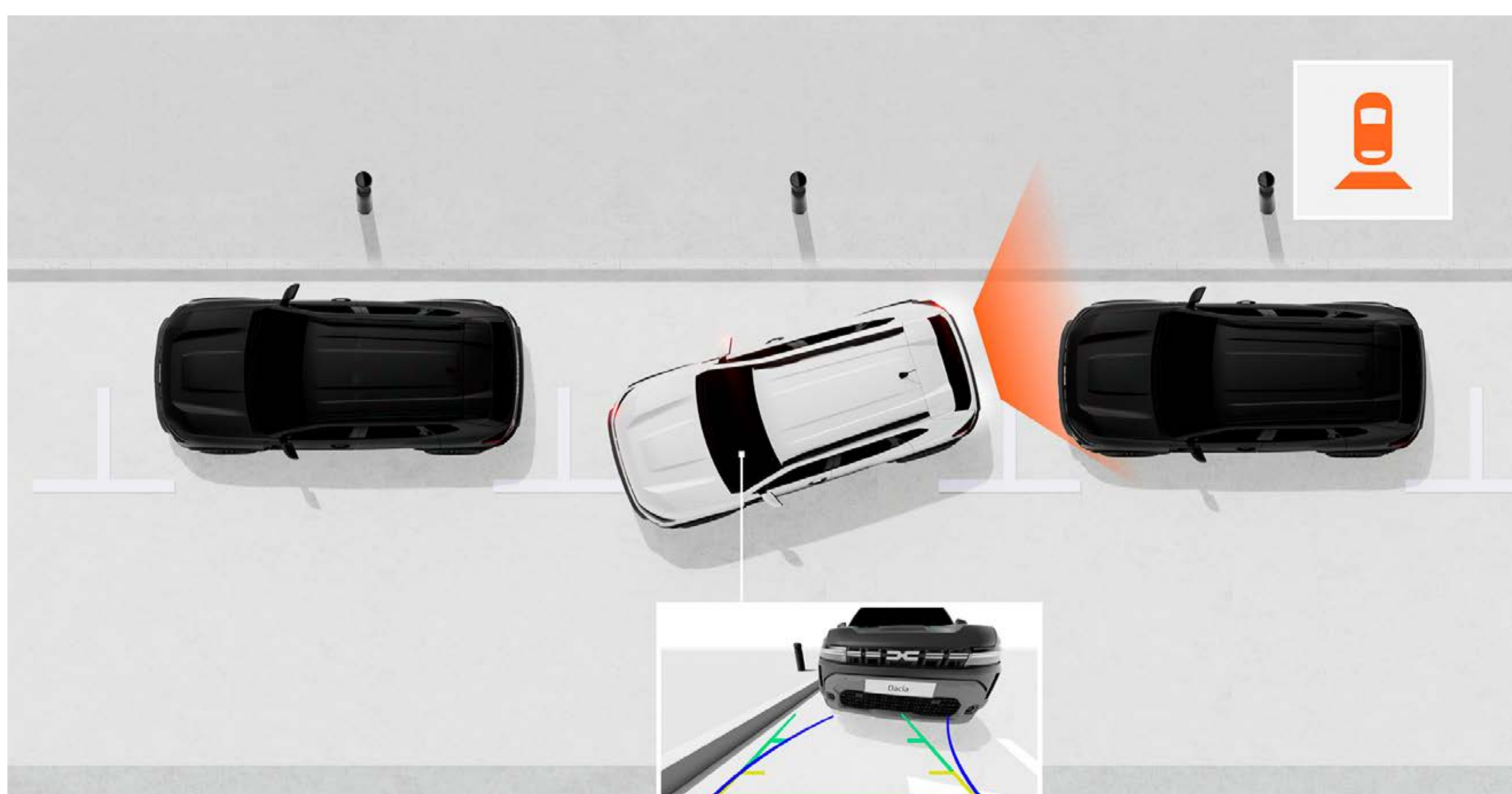

MULTIVIEW CAMERA

The MultiView Camera gives you more eyes! It provides front, rear and side views, helping you detect holes, rocks or obstacles that are not always easy to see, and making driving easier for you.*

* standard on Journey and Extreme

**FIND OUT MORE
ABOUT THE
EQUIPMENT** 

COLOUR PALETTE

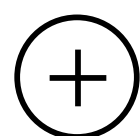

TRIMS

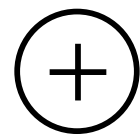

ACCESSORIES

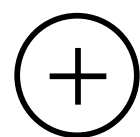

ENGINES

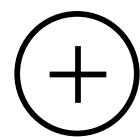

EQUIPMENT & OPTIONS

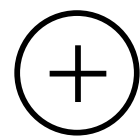

DIMENSIONS

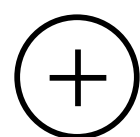

06. SPECIAL TECHNICAL FEATURES

COLOUR PALETTE

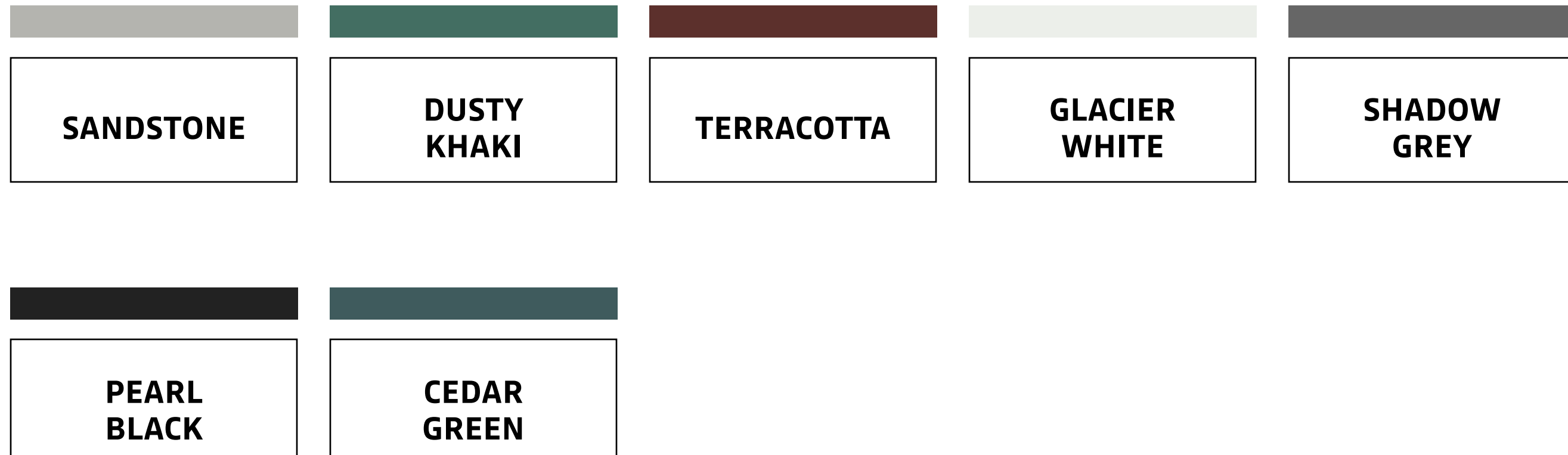

SANDSTONE⁽¹⁾



DUSTY KHAKI⁽²⁾⁽³⁾



TERRACOTTA⁽¹⁾



GLACIER WHITE⁽²⁾⁽³⁾



SHADOW GREY⁽¹⁾⁽³⁾



PEARL BLACK⁽¹⁾



CEDAR GREEN⁽¹⁾

Essential versions only glacier white, shadow grey and dusty khaki are available.

All other colours available as options from expression to extreme versions.

Special Paint is dusty khaki

(1) Metallic paint. (2) Solid paint. (3) available from Essential Versions.

Non-binding photos.

06. SPECIAL TECHNICAL FEATURES

TRIMS

ESSENTIAL



MAIN EQUIPMENT

EXTERIOR DESIGN

- Body coloured front and rear bumpers
- Front skid plates - grey
- 16" jante steel wheels
- Black door handles and door mirrors
- LED Dacia front signature lighting
- Longitudinal roof bars
- Black electrically-heated and defrosting door mirrors
- ECO-LED front headlights
- Wheel arch protection and snorkel in Starkle®

INTERIOR DESIGN

- Special Essential upholstery
- Black air vents
- Steel Grey interior door handles

ON-BOARD EXPERIENCE

- One-touch driver-seat window control
- Electric front passenger window
- 3 YouClip attachment points
- Remote central door locking
- Electric power-assisted steering with variable assistance
- Height-adjustable driver's seat
- Height- and depth-adjustable steering wheel
- Foldable key
- Analogue instrument cluster with 3.5" TFT screen
- New Media Control: DAB digital radio, jack and 1 USB-C sockets, 4 speakers, Bluetooth® telephone with side controls on the steering wheel, Dacia Media Control smartphone app
- USB connection for data transfer and charging

- Smartphone holder on dashboard
- 1/3-2/3 split folding rear bench seat
- Manual air conditioning system
- Luggage space cover

SAFETY AND DRIVING ASSISTANCE

- 6 airbags (driver and passenger front, curtain and side airbags)
- My Safety button to manage driver-assistance systems
- Anti-locking braking system (ABS) + Emergency Brake Assist (EBA)
- Automatic emergency braking (AEBS) with pedestrian/cyclist detection
- Electronic Stability Control (ESC) + Anti-Skid Regulation (ASR)
- Emergency call (E-call)
- Event (accident) data logger
- Vehicle pre-configuration for alcolock immobiliser
- Traffic sign recognition and speeding alert
- Lane change warning
- Lane keeping assist
- Driver fatigue detection system
- Front / rear "Rescue Code®" QR Code
- Automatic headlighting
- Eco-Mode, Stop & Start and gear change indicator
- Isofix attachment system on rear side seats
- Tyre inflation kit
- Soft feel steering wheel with speed limiter and cruise control and steering wheel controls
- Rear parking sensors

EXPRESSION



MAIN EQUIPMENT EXPRESSION = ESSENTIAL+

- **EXTERIOR DESIGN**
- 17" Tergan full diamond-cut alloy wheels
- Body-coloured door handles
- Silver-look door mirrors
- Megalith Grey front and rear skid plates
- Starkle® bottom door protectors

INTERIOR DESIGN

- Steel Grey air vents
- Blue denim front door pull handles
- Denim upholstery with reflective Dacia logo

ON-BOARD EXPERIENCE

- Front and rear one-touch electric windows
- 5 YouClip attachment points
- Configurable 7" digital instrument cluster
- New Media Display: multimedia system with 10" touch screen, radio, smartphone replication via USB cable or wireless via Wi-Fi, Bluetooth® telephone system, 4 speakers, USB-C Plug front and rear

- Centre console with armrest and storage compartment
- Foldable key

SAFETY AND DRIVING ASSISTANCE

- Rear-view camera
- Automatic windscreen wipers with rain sensor
- Downhill speed control (4x4 version)

OPTIONS

- Spare wheel + jack⁽¹⁾
- Metallic or special paint

(1) The "emergency spare wheel" option replaces the "tyre inflation kit".

JOURNEY



MAIN EQUIPMENT

JOURNEY = EXPRESSION+

EXTERIOR DESIGN

- 18" Tagasan alloy wheels
- Fog lights

ON-BOARD EXPERIENCE

- Split level boot floor (exclusive to Journey)
- Dark glass
- Automatic heating and air conditioning system
- Auto-fold door mirrors with control panel on driver's door
- Keyless entry
- Wireless charger
- Electric parking brake
- Rear 12V plug in boot
- 10.1" Media Nav Live with Connected Navigation, DAB Radio + Smartphone replication + Bluetooth + Connected Services + 6 Speakers with Apple Carplay and Android Auto + USB-C Plug (Front and Rear), plus access to apps vis app store

SAFETY AND DRIVING ASSISTANCE

- Front and rear parking sensors
- Multiview camera
- Blind spot warning
- Automatic switching between main/dipped headlights
- Downhill speed control (4x4 version)

OPTIONS

- Spare wheel + jack⁽¹⁾⁽²⁾
- Metallic or special-effect paint

(1) The "emergency spare wheel" option replaces the "tyre inflation kit". (2) Not available on Journey 4x4 version.

EXTREME



MAIN EQUIPMENT EXTREME = JOURNEY+

EXTERIOR DESIGN

- 18" Semi Diamond cut Tagasan Alloy Wheels
- Copper door mirror shells
- Modular roof bars
- Fog lights

INTERIOR DESIGN

- MicroCloud plastic-coated textile upholstery
- Front door inserts in washable MicroCloud plastic-coated textile with Copper Brown topstitching
- Copper Brown details on air vents

ON-BOARD EXPERIENCE

- Automatic air conditioning system
- Auto-fold door mirrors with control panel on driver's door
- Keyless entry
- 5 YouClip Fixation Points
- Rubber boot liner
- Screen-printed front and rear rubber floor mats
- Driver's seat with lumbar adjustment and passenger's seat with height adjustment
- Centre console with armrest and storage compartment
- Heated seats
- Wireless phone charger
- Heated steering wheel

SAFETY AND DRIVING ASSISTANCE

- Automatic switching between main/dipped headlights
- Downhill speed control (4x4 and 4x2 versions)

OPTIONS

- Spare wheel + jack⁽¹⁾
- Metallic or special-effect paint

(1) The "emergency spare wheel" option replaces the "tyre inflation kit".

[CONFIGURE AND ORDER](#)

[MENU](#) 

06. SPECIAL TECHNICAL FEATURES

ACCESSORIES

STYLE PACK

£258 inc. fitting



Shark antenna

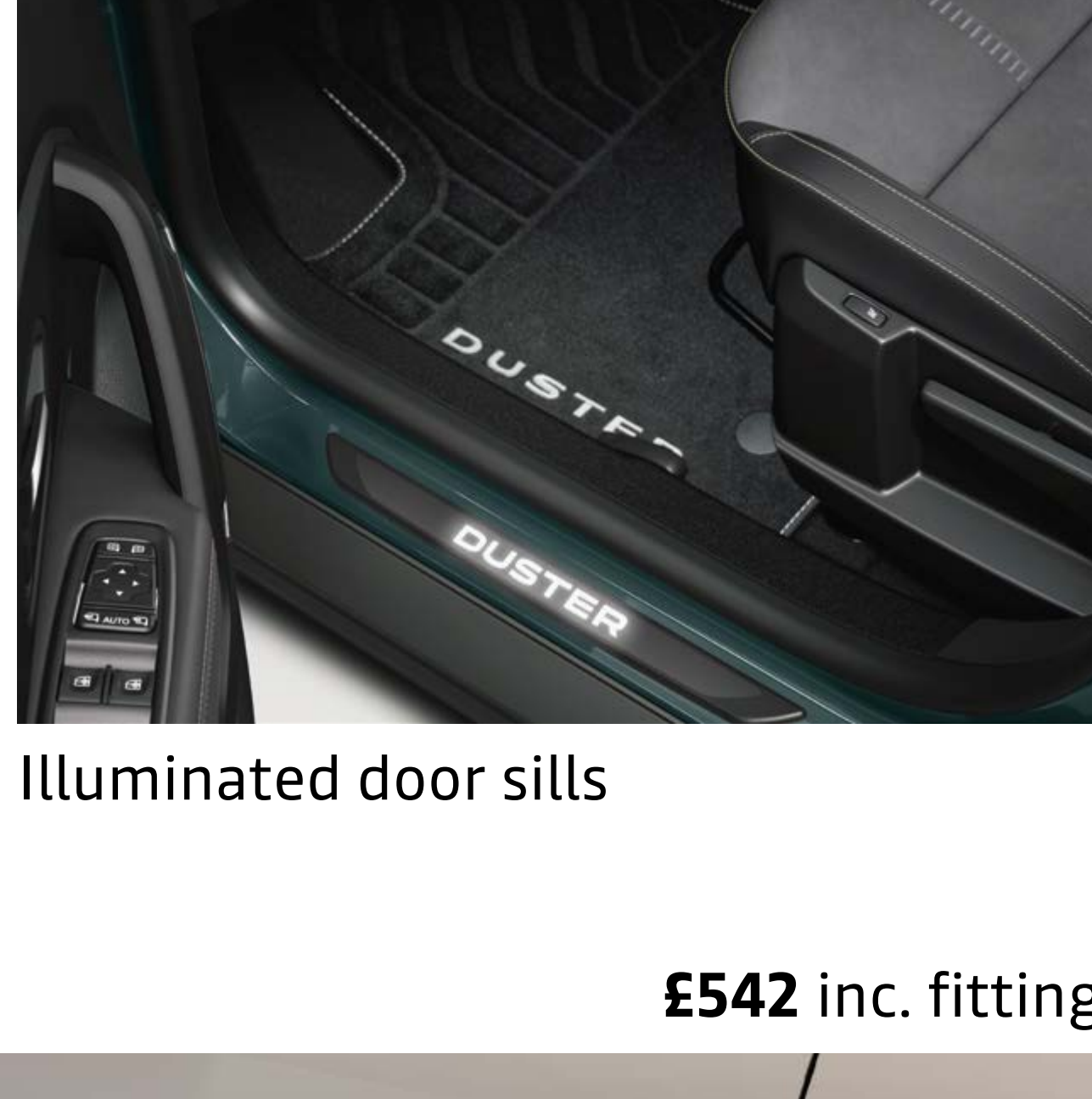

Illuminated door sills

SIDE STEP PACK

£542 inc. fitting



Side steps

PROTECTION PACK

£403 inc. fitting



Illuminated door sills

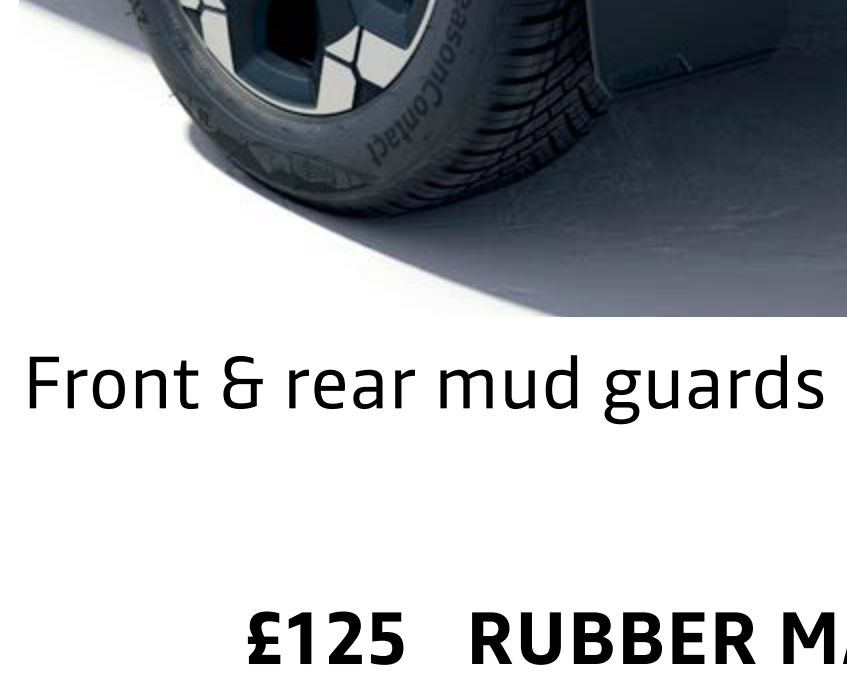

Front & rear mud guards

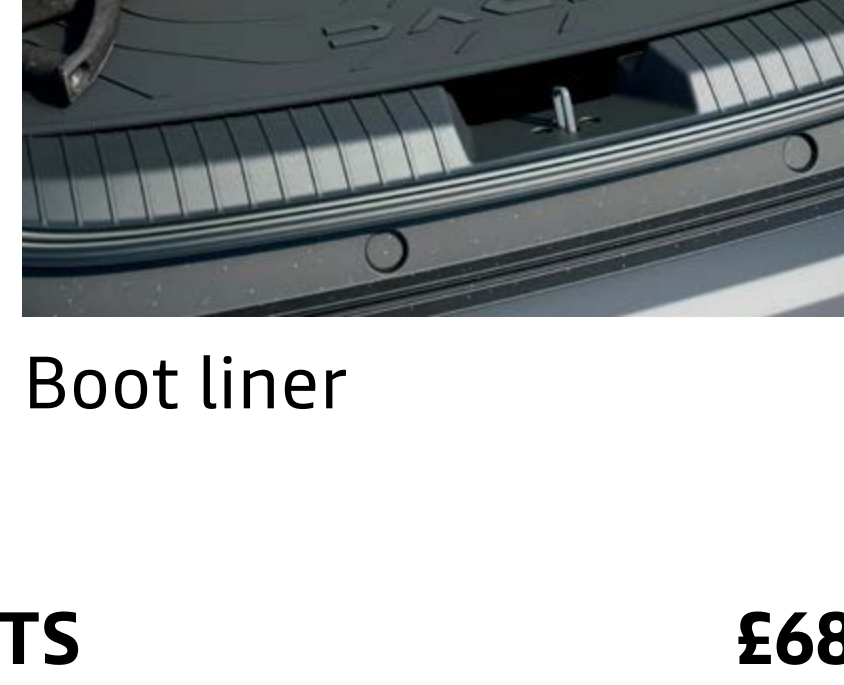

Boot liner

MODULAR BOOT LINER

£125

RUBBER MATS

£68

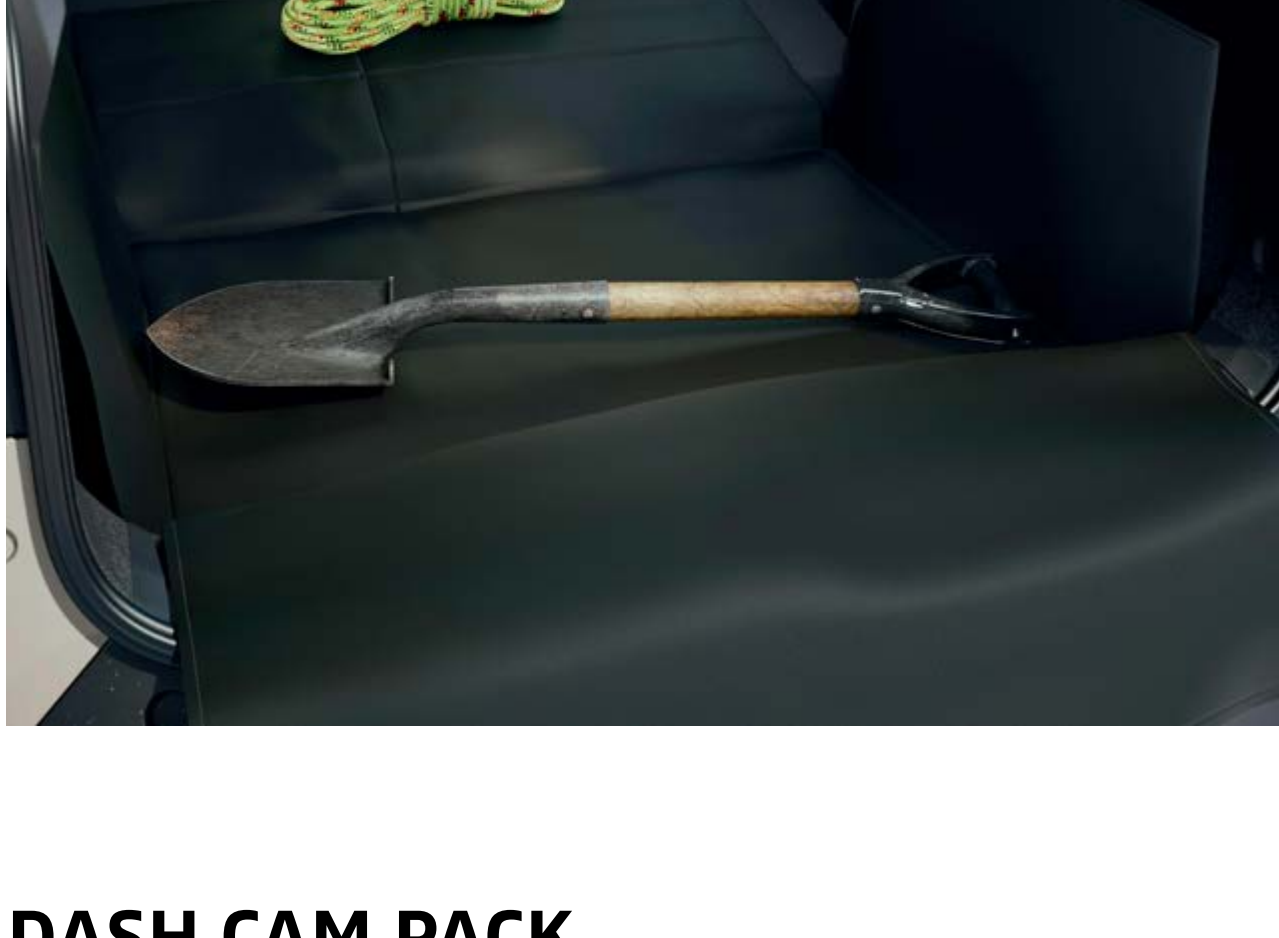

DASH CAM PACK

£344 inc. fitting



Front and rear dashcam

TOURING PACK

£569



Roof bars, Roof box 480L

CYCLE PACK

£460

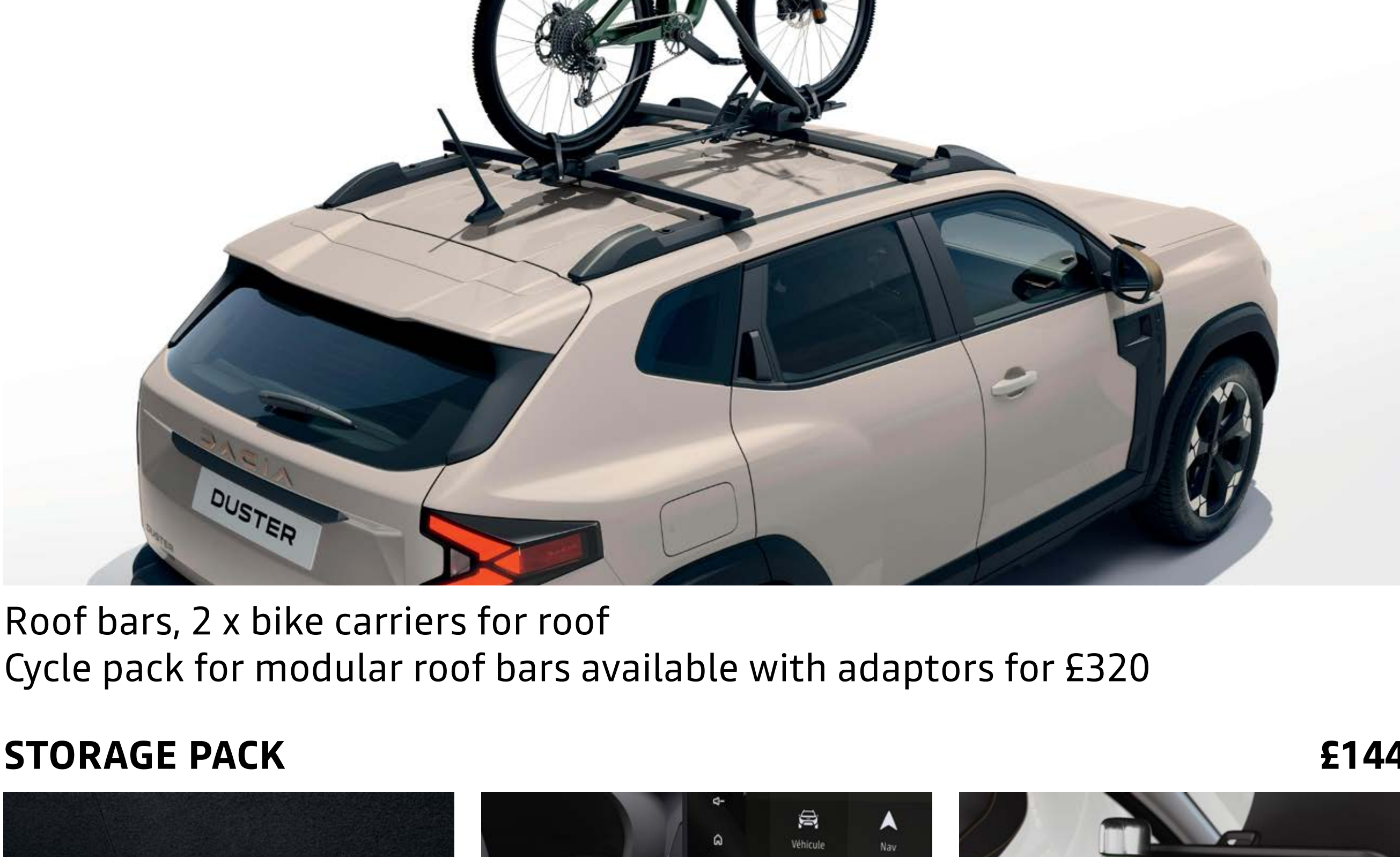

Roof bars, 2 x bike carriers for roof
Cycle pack for modular roof bars available with adaptors for £320

STORAGE PACK

£144



Boot storage net

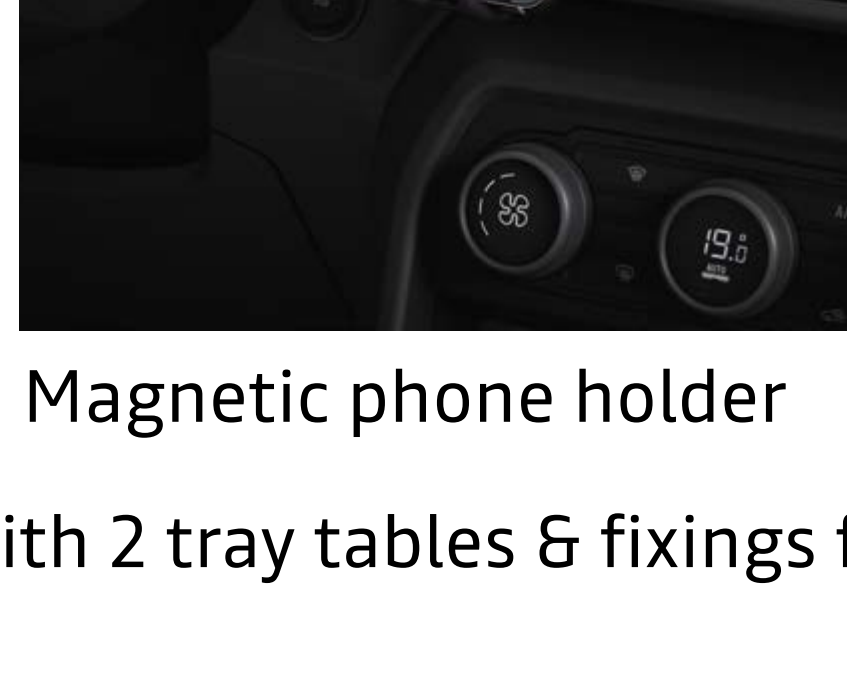

Magnetic phone holder

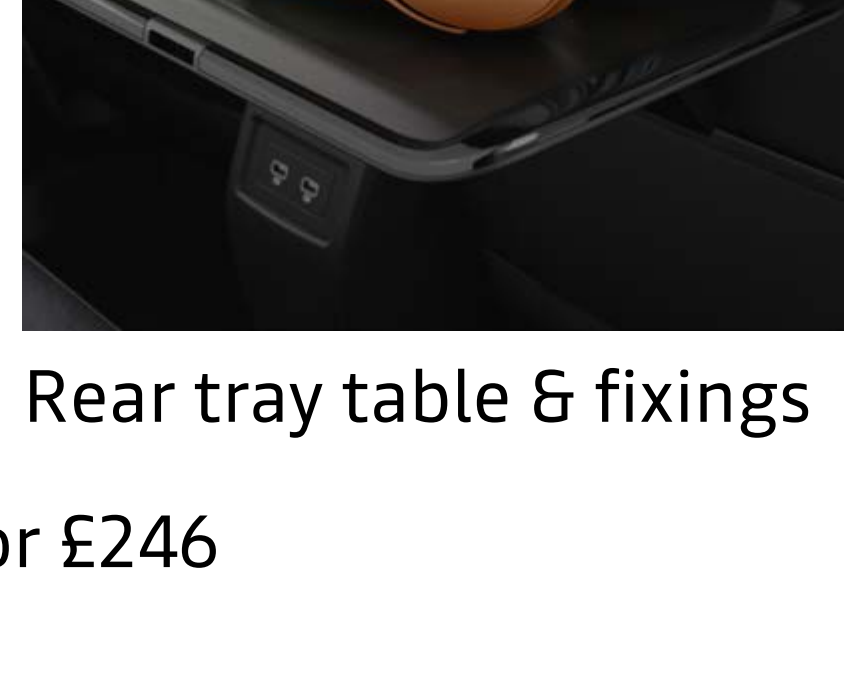

Rear tray table & fixings

Storage pack + available with 2 tray tables & fixings for £246

TOWBAR PACK



Swan neck towbar 13 pin
Removable towbar 13 pin

£642 inc. fitting
£691 inc. fitting

IN NATURE ROOF RACK

£708 inc. assembly

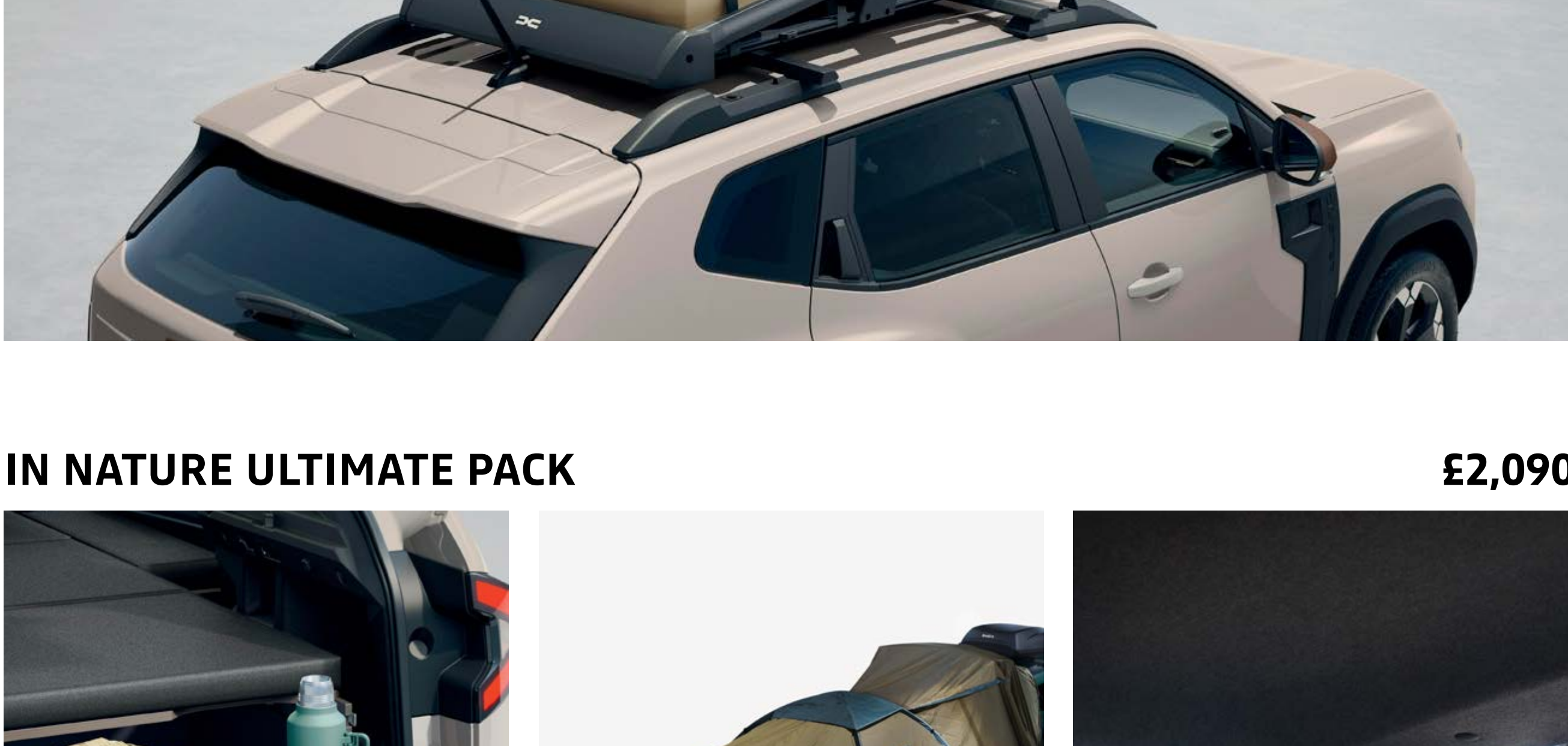

IN NATURE ULTIMATE PACK

£2,090



Mattress & box frame

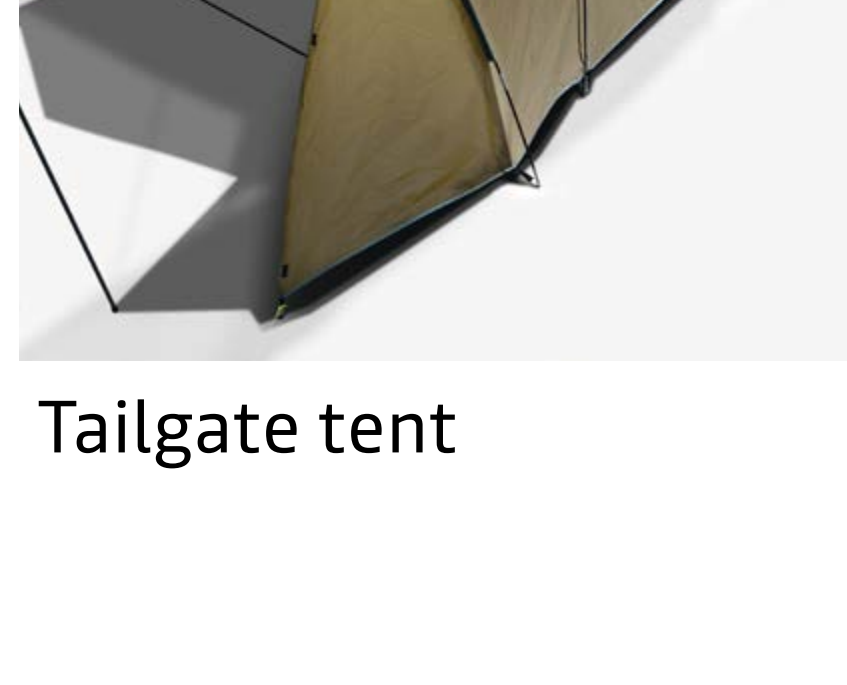

Tailgate tent

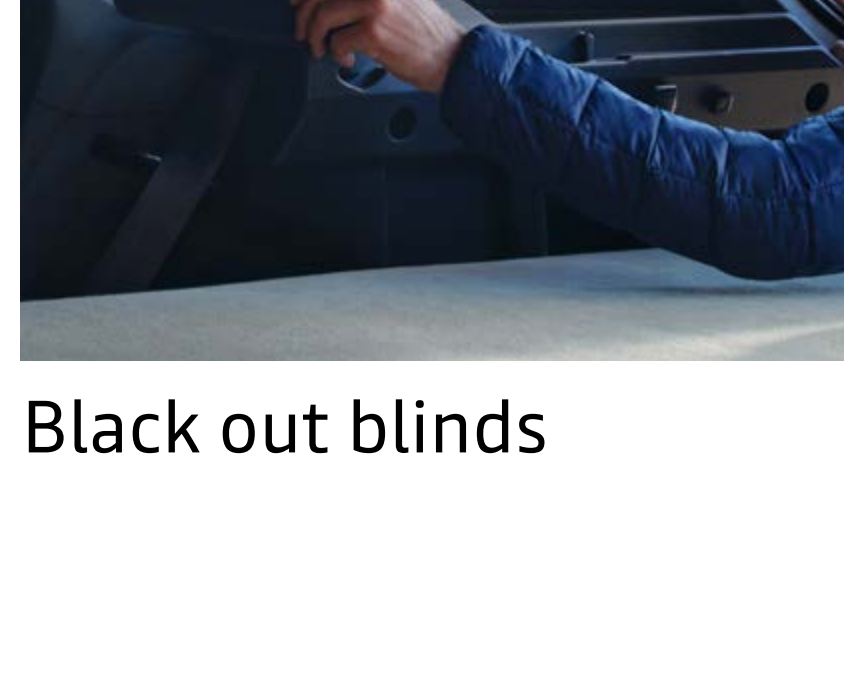

Black out blinds

YOUCLIP ON THE GO

£40

£15

£10



3-in-1 cup holder (cup holder + lamp + hook)



Multifunction cup holder

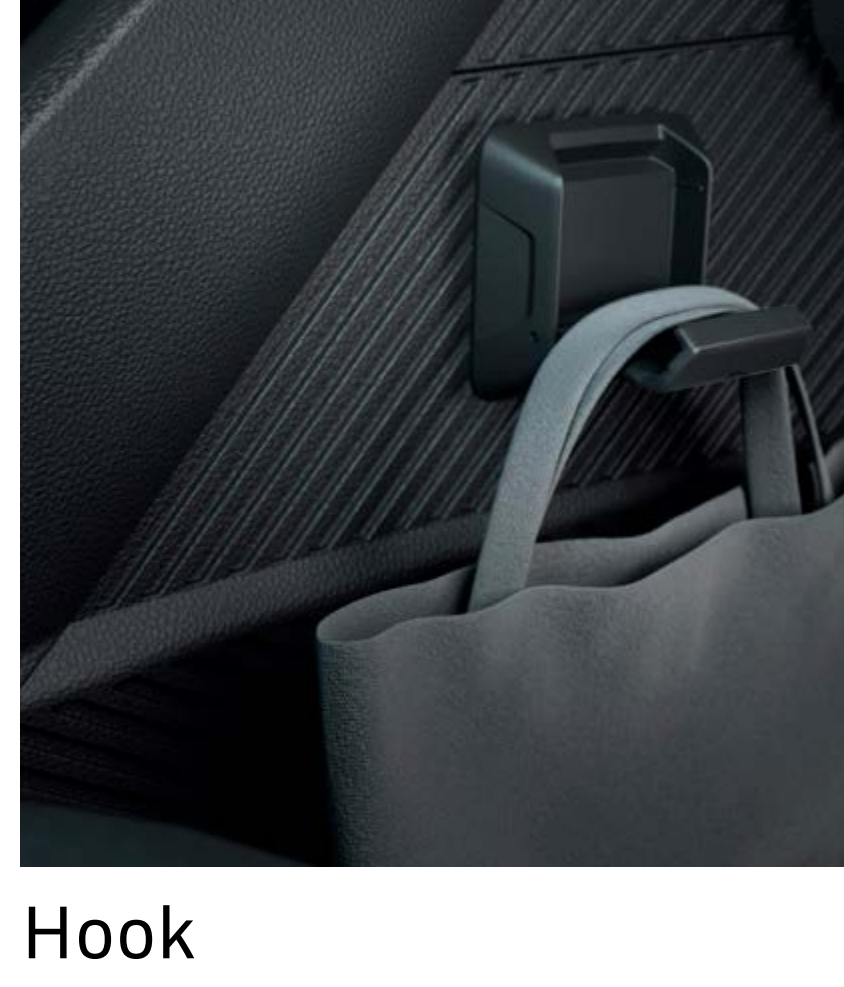

Hook



Lamp



Bag



Wireless smartphone charger

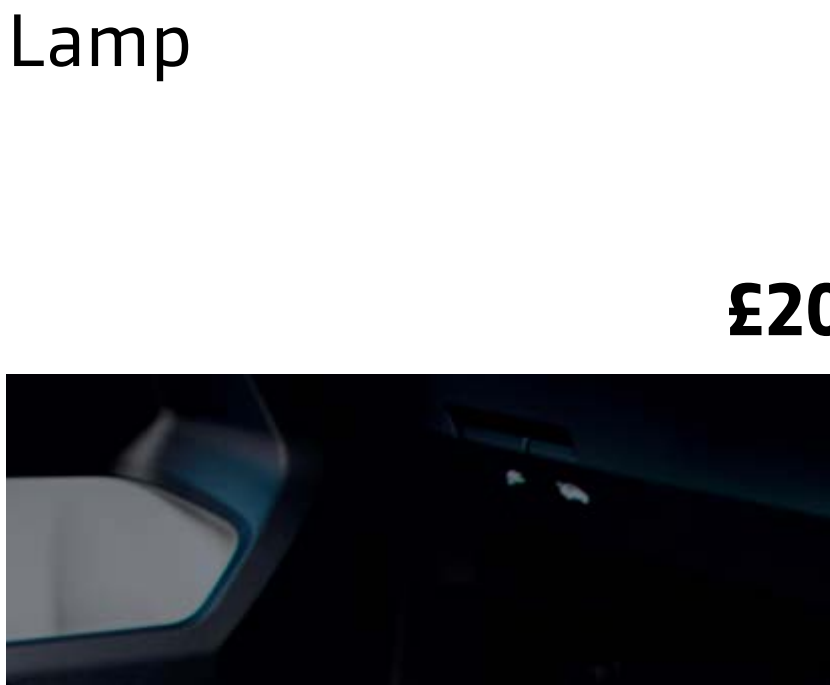

Smartphone holder



Tablet holder



Headrest base mount

PREMIUM DELIVERY PACKS

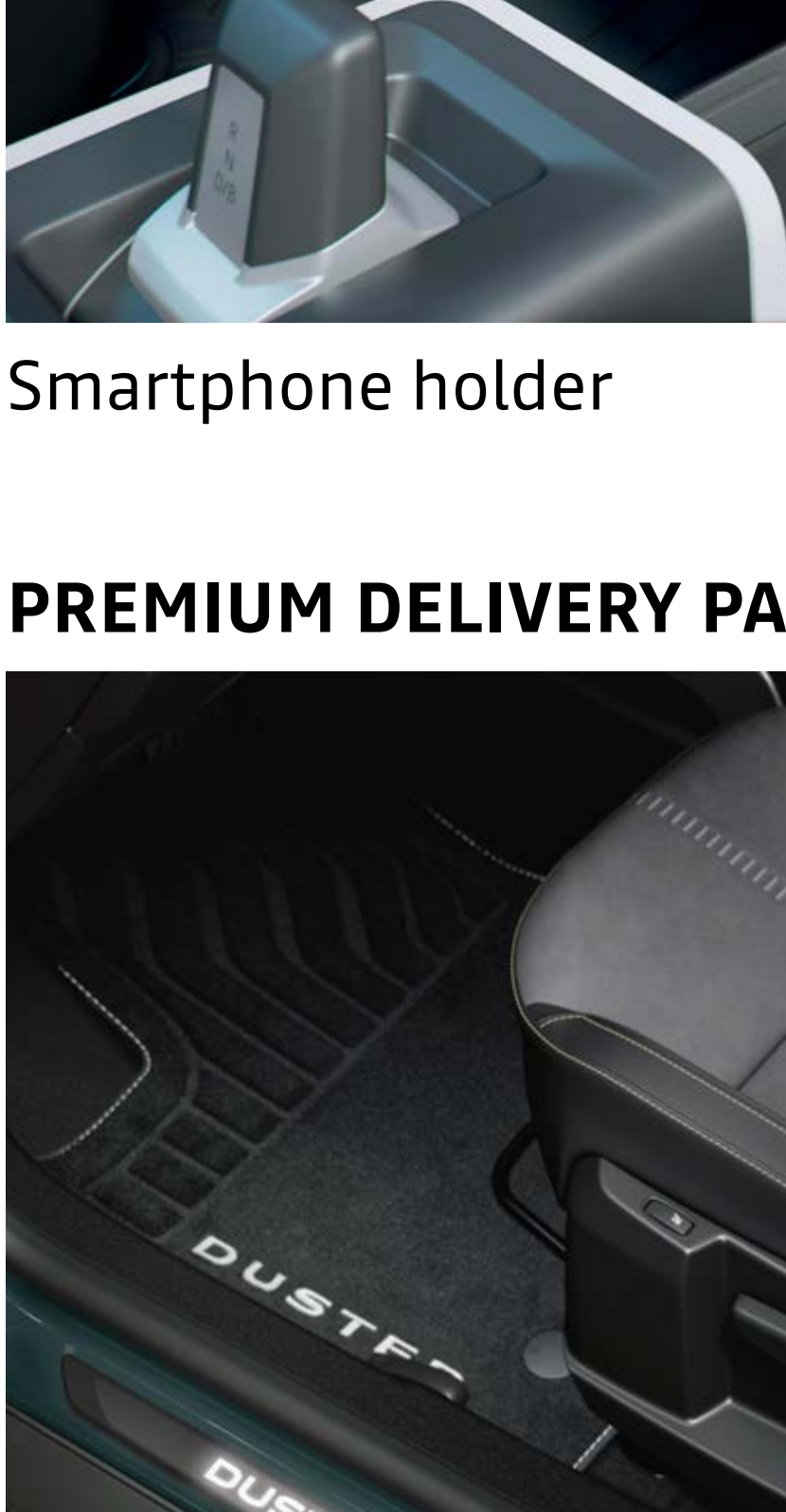

Premium textile floor mats

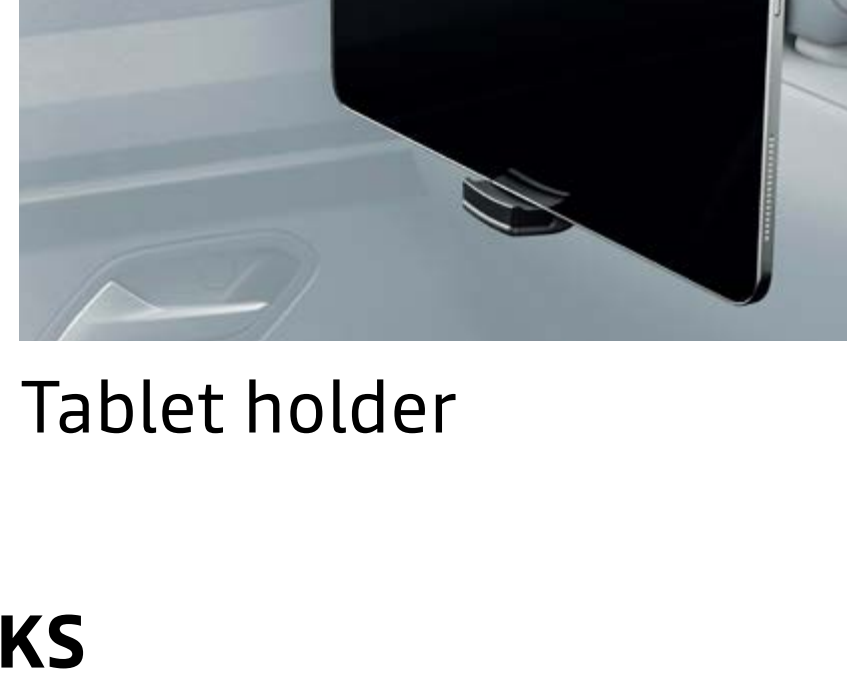

Safety kit



Key card wallet



Rubber boot liner

PREMIUM DELIVERY PACK

£100

Premium textile floor mats
Safety kit
Key card wallet

PREMIUM DELIVERY PACK+

£165

Premium textile floor mats
Safety kit
Key card wallet
Rubber boot liner

All accessories purchased prior to vehicle registration come with a 3 year manufacturers warranty
Accessories are fitted post production and may have an impact on WLTP fuel (actual) consumption and CO₂ figures

DOWNLOAD
THE ACCESSORIES BROCHURE

06. SPECIAL TECHNICAL FEATURES

ENGINES

	ECO-G 100	TCe 130	TCe 130 4X4	Hybrid 140
ENGINES				
Energy	Petrol / LPG	Petrol / Electric mild hybrid 48 V	Petrol / Electric mild hybrid 48 V	Petrol / Electric full hybrid 230 V
Max. power kW EEC (hp) at an engine speed of (rpm)	74 (100 hp) at 4,400-4,900/4,600-5,000	96 (130 hp) at 4,500-5,500	96 (130 hp) at 4,500-5,500	105 (140 hp) at 5,600*
Max torque Nm EEC (m.kg) at an engine speed of (rpm)	160/170 at 2,200-3,750/2,000-3,500	230 at 2,100-3,500	230 at 2,100-3,500	148 at 3,600
Injection type	MPI	Direct injection	Direct injection	MPI
Capacity (cm3)	999	1199	1199	1598
No. of cylinders/valves	3 cylinders/12 valves	3 cylinders/12 valves	3 cylinders/12 valves	4 cylinders/16 valves
Emission control standard	E06W			
Particle filter(1)	yes			
Stop & Start(2)	yes			

BATTERIES				
Traction battery	-	Lithium-ion / 48 V / 0.84kWh	Lithium-ion / 48 V / 0.84kWh	Lithium-ion / 230 V / 1.2 kWh

PERFORMANCE				
Top speed (mph)/0-100mph (s)	104 (LPG) / 101 (petrol)	111	111	105
0-62 mph (s)	13.2 (LPG) / 14.1 (petrol)	9.9	11	10.1

GEARBOX AND TRANSMISSION				
Transmission	4x2	4x2	4x4	4x2
Gearbox type / Number of gears	6	6	6	Multi-mode automatic / 4+2

STEERING				
Steering	Electrical power-assisted steering			
Turning circle, kerb to kerb (m)	10.86			

BRAKING				
Front: ventilated disc (VD)/ diameter (mm)	280	280	280/296	296
Rear: drum (D)/diameter (inches)	T9/280			

WHEELS AND TYRES				
Reference tyre sizes	215/70 R16 100H	215/65 R17 99H 215/60 R18 98H	215/65 R17 99H 215/60 R18 98H	215/65 R17 99H 215/60 R18 98H

FUEL CONSUMPTION AND EMISSIONS(3)				
Certification protocol	WLTP(4)			
Eco mode	Yes			
Fuel tank capacity (litres)	LPG: 51 / Petrol: 50	Petrol: 50	Petrol: 50	Petrol: 50
CO ₂ emissions (g/km)	LPG: 126 / Petrol: 147	124	135	114
Consumption over a combined cycle (mpg)	LPG: 35 / Petrol: 43	51	46	55

WEIGHTS (KG) AND VOLUMES (DM3 OR LITRES)				
Minimum Kerb weight	1276	1304	1390	1380
Max. unladen kerb weight	1308	1346	1436	1422
Gross train weight (GTW)	2965	3300	3395	2620
Maximum permissible laden weight (MPLW)	1765	1800	1895	1870
Max./min. payload(5)	457/489	454/496	459/505	448/490
Max. braked towing weight	1200	1500	1500	750
Max. unbraked towing weight	675	685	730	725
Min. boot volume under luggage space cover with repair kit /with spare wheel(6) (dm3 VDA)	453	517	456	430
Max. boot volume with rear bench seat folded down with repair kit/ with spare wheel(6) (dm3 VDA)	1,545	1,609	1,548	1,545
Min. boot volume under luggage space cover with repair kit/with spare wheel (litres)	513	594	520	496
Max. boot volume with rear bench seat folded down with repair kit/ with spare wheel (litres)	1,632	1,696	1,635	1,609

(1) Petrol engines with particle filter (DPF): to reduce particle emissions, the new direct injection petrol engines now include a particle filter in the exhaust line. The filter retains the particles present in the exhaust gases, then burns them via automatic and regular regeneration. The particulate filter requires no maintenance. (2) The vehicle's starter and battery are adjusted for use with the Stop & Start system. (3) Official consumption and emissions according to applicable regulations. (4) WLTP (Worldwide Harmonized Light Vehicle Test Procedures): this new protocol provides results much closer to those found in daily use compared to the NEDC protocol. CO₂ emissions are certified using a standard, regulatory method. This method is identical for all manufacturers and enables vehicles to be compared. (5) The payload indicated is at the lowest equipment level. (6) According to ISO standard 3832.

* Combined power of internal combustion and electric engines. ** Maximum speed with electric overtorque for a limited period of time. *** Maximum speed on internal combustion engine only.

CONFIGURE AND ORDER

MENU 

06. SPECIAL TECHNICAL FEATURES

EQUIPMENT & OPTIONS

	ESSENTIAL	EXPRESSION	JOURNEY	EXTREME
EXTERNAL APPEARANCE				
LED brand light	•	•	•	•
Front/rear bumper	Body-coloured	Body-coloured	Body-coloured	Body-coloured
Automatic activation of daytime running lights	•	•	•	•
Black Grille with white trim	•	•	•	•
Front and rear skid plates	Steel Grey	Steel Grey	Steel Grey	Steel Grey
Exterior door handles	Black	Body-coloured	Body-coloured	Body-coloured
Door mirrors	Black	Grey	Grey	Copper
Longitudinal roof bars	•	•	•	-
Modular roof bars	-	-	-	•
Tinted windows (rear, quarter panels, tailgate)	-	-	•	•
16" Jante steel wheels	•	-	-	-
17" Tergan diamond cut alloy wheels	-	•	-	-
18" Tagasan diamond-cut alloy wheels	-	-	•	-
18" Tergan semi-diamond-cut alloy wheels	-	-	-	•
SEATS AND INTERIOR TRIMS				
Air vent surrounds	Steel Grey	Steel Grey	Steel Grey	Copper
Interior door handles	Steel Grey	Steel Grey	Steel Grey	Steel Grey
Front door pull handles	Grey	Denim	Denim	Khaki
Split-fold rear bench 1/3 & 2/3	•	•	•	•
Soft feel steering wheel	•	•	•	•
Special Essential upholstery	•	-	-	-
Special Denim upholstery with reflective Dacia logo	-	•	•	-
MicroCloud coated fabric upholstery	-	-	-	•
ACTIVE AND PASSIVE SAFETY				
Traffic sign recognition and speeding alert	•	•	•	•
Emergency call (E-call)	•	•	•	•
Anti-locking braking system (ABS) + Emergency Brake Assist (EBA) with emergency stop signal	•	•	•	•
Automatic emergency braking system (AEBS) with vehicle, pedestrian, cyclist and motorcycle detection	•	•	•	•
Lane change warning	•	•	•	•
Lane keeping assist	•	•	•	•
Driver fatigue detection system	•	•	•	•
My Safety button to easily enable/disable driver assistance systems ⁽³⁾	•	•	•	•
Front / rear Rescue Code [®] QR Codes	•	•	•	•
Electronic Stability Control (ESC) ⁽¹⁾ with Hill Start Assist (HSA)	•	•	•	•
Driver's front airbag	•	•	•	•
Passenger's front airbag, disconnectable	•	•	•	•
Shoulder and curtain side airbags	•	•	•	•
Front and rear seat belts with pyrotechnic pretensioner	•	•	•	•
Tyre pressure detection	•	•	•	•
3rd 3-point rear seat belt (inertia reel)	•	•	•	•
Spare wheel + jack ⁽²⁾	-	○	○	○
Tyre inflation kit	•	•	•	•
Isofix mounts for child seats in both side rear seats	•	•	•	•
Electric parking brake	-	•	•	•
DRIVING AND CONTROL INSTRUMENTS				
Electrical power-assisted steering	•	•	•	•
YouClip – smartphone bracket	-	-	•	•
Analogue instrument cluster with 3.5" TFT screen and 13-function on-board computer	•	-	-	-
Configurable 7" digital instrument cluster and 13-function on-board computer	-	•	•	•
Visual and audible front seat belt warning	•	•	•	•
Eco Mode (FOR EURO6 COUNTRIES to be adapted) + Stop & Start + gear change indicator	•	•	•	•
Downhill speed control system	-	• (4x4 versions only)	• (4x4 versions only)	•
Cruise control and speed limiter	•	•	•	•
Rear parking sensors	•	•	•	•
Front and side sensors	-	-	-	-
Rear-view camera	-	•	-	-
Multiview camera	-	-	•	•

• : available as standard; ○ : available as an option; - : not available. (1) Can only be disconnected on 4x4 versions. (2) The "spare wheel + jack" option replaces the "tyre inflation kit". (3) For configurable driving assistance systems.

VISIBILITY

Front fog lights	-	-	•	•
Heated rear screen/timed rear screen wiper	•/•	•/•	•/•	•/•
Heated electric door mirrors	•	•	•	•
Automatic windscreen wipers	-	•	•	•

COMFORT

Manual heating and air conditioning system	•	•	-	-
Automatic heating and air conditioning system	-	-	•	•
Automatic folding door mirrors	-	-	•	•
Electric door locking with radio frequency remote	•	•	•	•
Hands-free card	-	-	•	•
Electric front windows	•	•	•	•
Electric rear windows	-	•	•	•
Height- and depth-adjustable steering wheel	•	•	•	•
Height-adjustable driver's seat	•	•	•	•
Height-adjustable driver's seat with lumbar adjustment	-	-	-	•
Semi-high centre console with sliding plastic-coated fabric armrest and storage compartment	-	•	•	•
2 USB ports at the rear of the console	-	•	•	•
Front reading light	•	-	-	-
2 front reading lights	-	•	•	•
1 reading light for rear passengers	-	-	•	•
12V sockets in front/rear	•/•	•/•	•/•	•/•
Boot lighting	•	•	•	•
Wireless charger	-	-	•	•
Heated steering wheel	-	-	-	•

MULTIMEDIA & AUDIO

New Media Control: DAB digital radio, jack socket and 2 USB-C sockets, 4 speakers, Bluetooth® connection with satellite controls on the steering wheel, fixed smartphone holder on the dashboard, new Dacia Media Control smartphone app	•	-	-	-
New Media Display: multimedia system with 10" touchscreen, DAB digital radio, smartphone mirroring via USB cable or wireless via Wi-Fi, Bluetooth® connection, satellite controls on steering wheel, 4 speakers and remote services pack (see Connected services)	-	•	-	-
New Media Nav live: multimedia system with 10" touchscreen, connected navigation with automatic map update, real-time traffic info and danger zones for 8 years (including licence and mobile data), DAB digital radio, smartphone mirroring via USB cable or wireless via Wi-Fi, Bluetooth® connection, steering wheel satellite controls, 6 speakers, Arkamys 3D sound®, Dacia app store and Remote services pack (see Connected services)	-	○	•	•

CONNECTED SERVICES

Remote services pack (via the MY Dacia application) included for 8 years: find my vehicle (remote geolocation on map, my dashboard data (mileage travelled, remaining driving range)	-	•	•	•
FOTA (Firmware Over-The-Air): allows software corrections and enhancements to be made directly to the car, without going through the dealer (up to 5 years)	-	•	•	•
Vehicle pre-equipped for "Pay as you drive" and/or "Pay how you drive" connected car insurance without the need for an additional unit ⁽⁴⁾	-	•	•	•

• : available as standard; ○ : available as an option; - : not available. (1) Can only be disconnected on 4x4 versions. (2) The "spare wheel + jack" option replaces the "tyre inflation kit". (3) For configurable driving assistance systems. (4) Connected insurance services available depending on the insurance company. Please contact your insurer.

CONFIGURE AND ORDER

MENU 

PRICING

	CO ₂ G/KM WLTP	FUEL TYPE	COMBINED FUEL CONSUMPTION (MPG) - WLTP	HP	BENEFIT IN KIND	VED YEAR 1	BASIC PRICE	VAT 20%	TOTAL RETAIL PRICE	ON THE ROAD PRICE*
ESSENTIAL										
TCe 100 Bi-Fuel	147 / 126	Petrol	6.5 Petrol / 8 LPG	100	34%	£260	£14,862.50	£2,972.50	£17,835	£18,850
EXPRESSION										
TCe 130 4x2	124	Petrol	5.5	130	29%	£220	£16,979.17	£3,395.83	£20,375	£21,350
TCe 130 4x4	135	Petrol	6	130	32%	£270	£18,770.83	£3,754.17	£22,525	£23,550
HYBRID 140	114	Petrol / Electricity	5	140	27%	£210	£19,487.50	£3,897.50	£23,385	£24,350
JOURNEY										
TCe 130 4x2	124	Petrol	5.5	130	29%	£220	£18,395.83	£3,679.17	£22,075	£23,050
TCe 130 4x4	135	Petrol	6.1	130	32%	£270	£20,187.50	£4,037.50	£24,225	£25,250
HYBRID 140	114	Petrol / Electricity	5.1	140	27%	£210	£20,904.17	£4,180.83	£25,085	£26,050
EXTREME										
TCe 130 4x2	124	Petrol	5.5	130	29%	£220	£19,062.50	£3,812.50	£22,875	£23,850
TCe 130 4x4	135	Petrol	6.1	130	32%	£270	£20,854.17	£4,170.83	£25,025	£26,050
HYBRID 140	114	Petrol / Electricity	5.1	140	27%	£210	£21,570.83	£4,314.17	£25,885	£26,850

* "On the Road" price includes delivery to the dealer premises, number plates, 12 months government road fund license (depending on CO₂ emissions) and First Registration Fee at £55.

OPTIONS

	EXPRESSION	JOURNEY	EXTREME	BASIC PRICE	VAT 20%	TOTAL RETAIL PRICE
Metallic & opaque paint	○	○	○	£541.67	£108.33	£650
Spare Wheel (excluding Bi-Fuel and Journey 4x4)**	○	○	○	£250.00	£50.00	£300

** Also available on hybrid versions.

DIMENSIONS

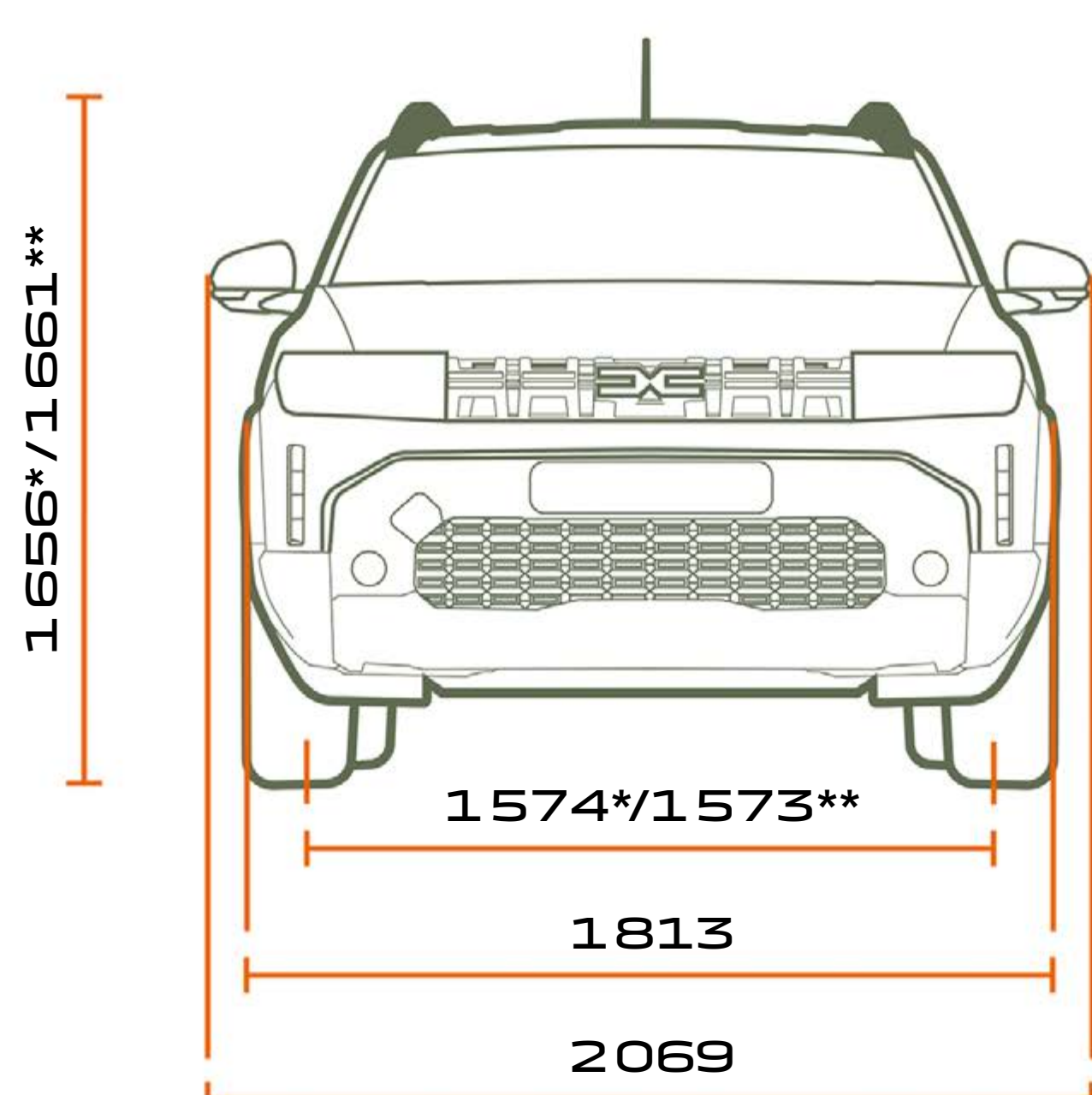

FRONT VIEW

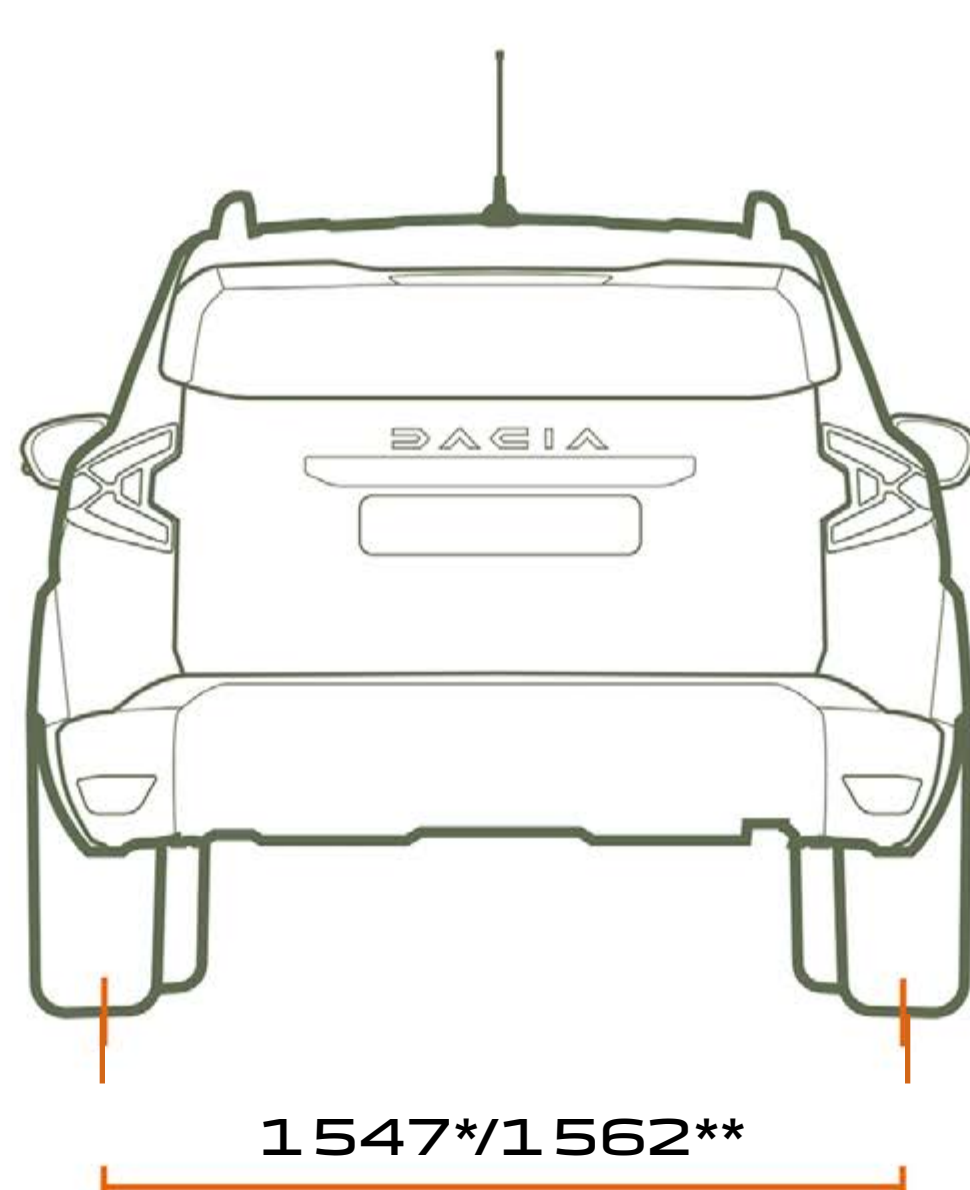

REAR VIEW

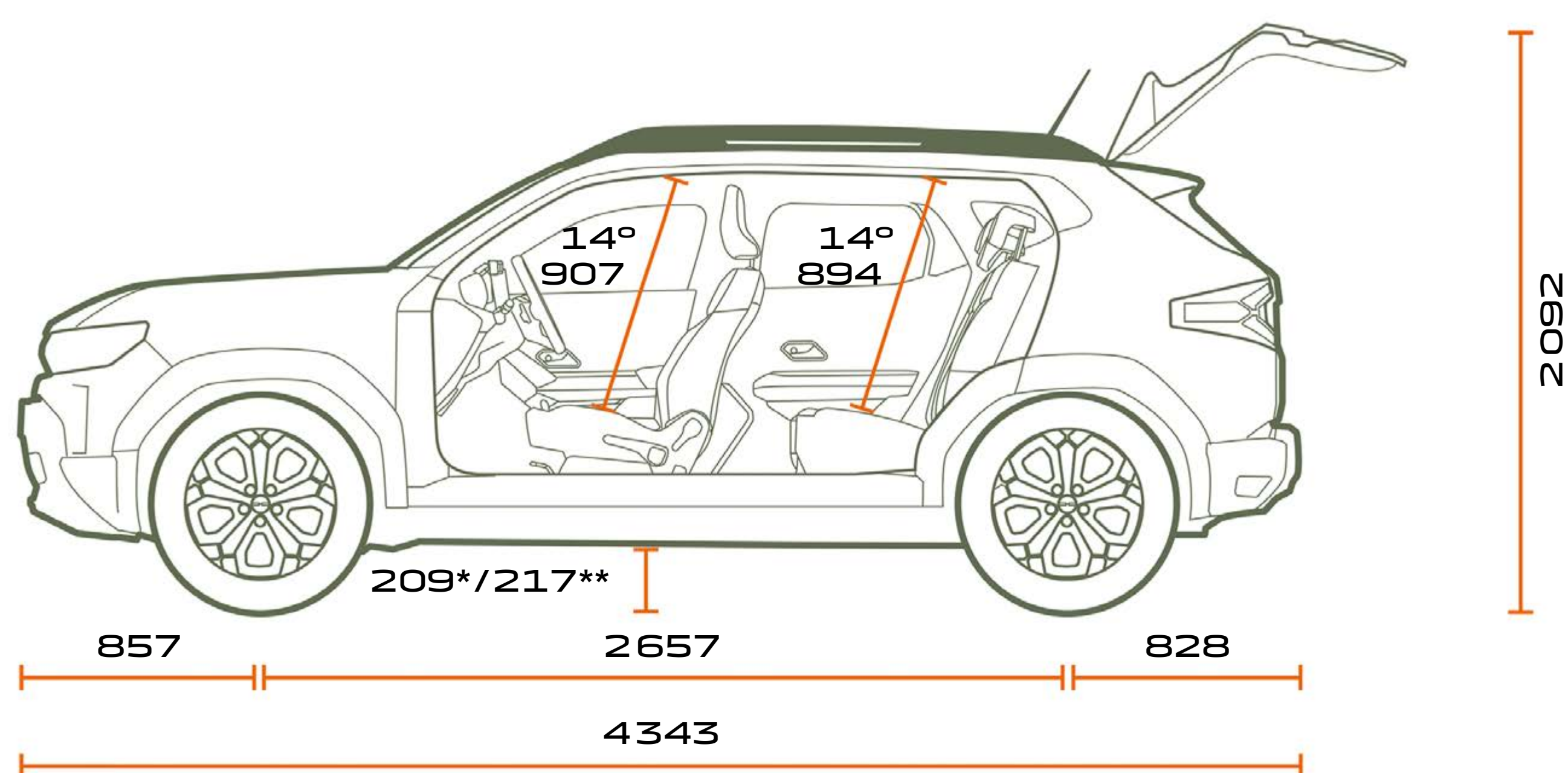

PROFILE VIEW

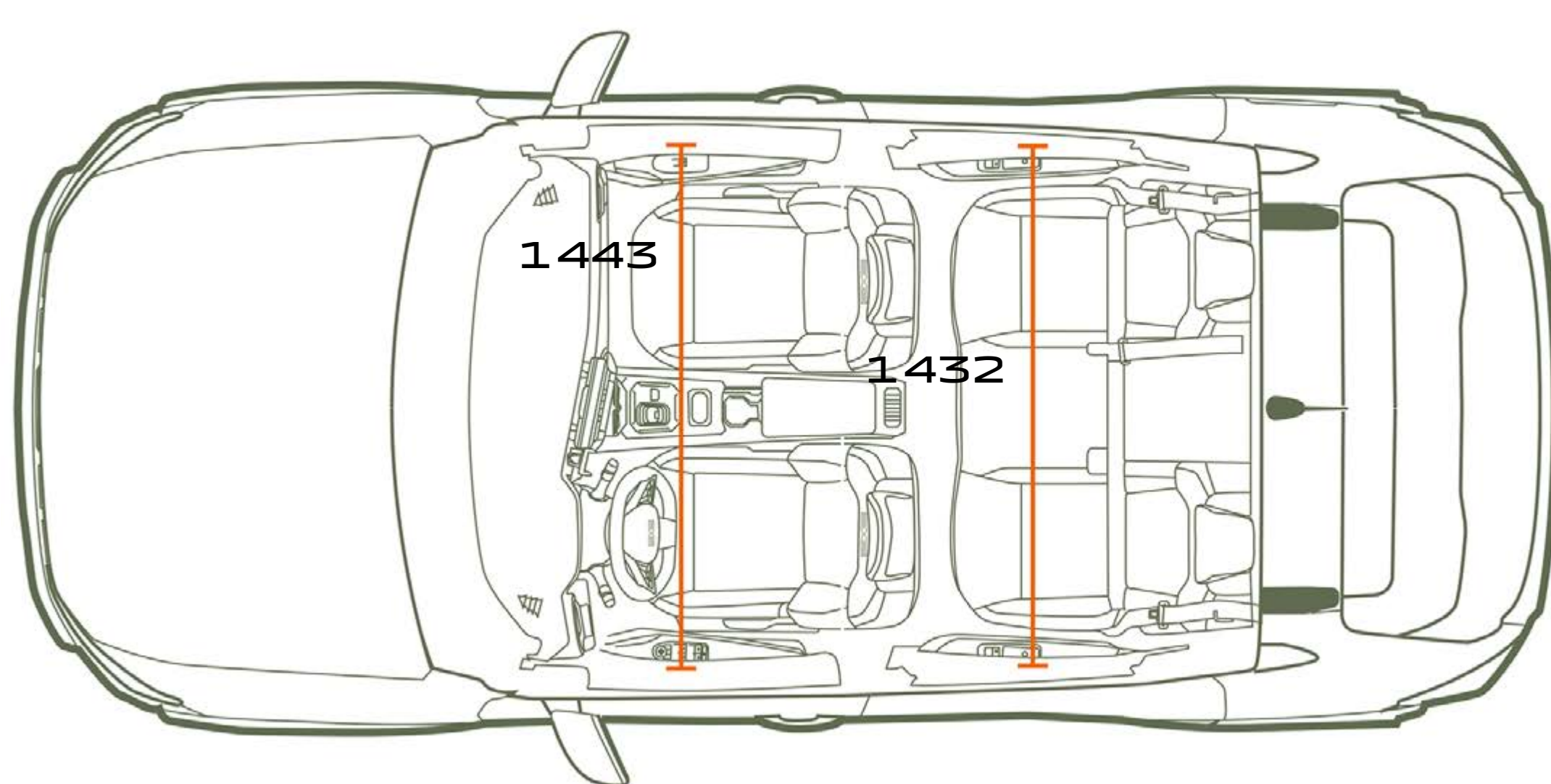

TOP VIEW

**BOOT VOLUME
(IN DM3 - VDA/LITRES STANDARD)**

Min. boot volume under luggage space cover with spare wheel (4x2/4x4)	478/414
Max. boot volume with rear bench seat folded down with spare wheel (4x2/4x4)	1,623 / 1,559

Dimensions in mm.
* 4x2 version
** 4x4 version

CONFIGURE AND ORDER

MENU ^

ENJOY THE RIDE WITH
DACIA ZEN



DACIA ZEN ENABLES OWNERS TO ENJOY UP TO SEVEN YEARS OF WARRANTY

- Brand new Dacia Zen warranty offers Dacia owners up to seven years of cover
- It's applicable to all Dacia models under six years old which have covered less than 75,000 miles
- Warranty is complimentary with every service completed at an official Dacia retailer
- Dacia Zen is available to owners of qualifying vehicles even if their Dacia has been previously serviced outside of the official Dacia retail network

WHO BETTER TO LOOK AFTER YOUR DACIA, THAN DACIA?

Are you the proud owner of a new or used Dacia? If your vehicle is less than 6 years old and has covered less than 75,000 miles you can get up to 7 years warranty with Dacia*

It's simple. Get your Dacia serviced by one of our expert retailers after your standard 3-year warranty expires and enjoy a Dacia ZEN warranty for a year or 18,000 miles (whichever comes sooner).

Enjoy the ride with Dacia ZEN.



Your Dacia is less than 6-years old and has done less than 75,000 miles



Have your next manufacturer service carried out in our retailer network



Get an additional 1-year of warranty*

*Warranty activated following service at participating Dacia Dealers. Valid for 1 year or 18,000 miles (whichever comes first). Vehicles over 6 years old or 75,000 miles not eligible. Full T&Cs apply.

[BOOK A SERVICE](#)

WE'VE GOT YOU COVERED

You might think our shockingly affordable prices mean our cars aren't made to last. Actually, the Dacia range is one tough cookie. To prove it, you get a 3-year* warranty (or 60,000 miles, if you reach that first). This means we will replace any part which has been deemed by a Dacia approved dealer to be defective due to a manufacturing fault, free of charge. To keep the good times rolling, you can extend your warranty up to 7 years for a great price. We also give you a 2-year paintwork and 6-year anti-corrosion warranty, so you can kick back knowing that your Dacia will stay looking good-as-new for years to come.

ROADSIDE ASSISTANCE

Although our cars are built for plain sailing, you can rely on us if you have a breakdown – 24/7 365, wherever you are in the UK or Northern Ireland. This offer also stands for the first 3 years/60,000 miles Δ after you buy your new Dacia.

DACIA CAR INSURANCE 1

Dacia Insurance has been specifically created to provide superb protection for you and your car. Unlike most other UK insurers, in the event of an accident, your Dacia will be repaired at a Dacia Approved Bodyshop using only Dacia approved parts and approved repair methods. This maintains your Dacia's safety rating, protects its resale value and helps to maintain its Dacia warranty \wedge . Dacia Insurance also offers a courtesy car for the duration of a repair at a Dacia Approved Bodyshop.

Dacia car insurance: 0330 102 7795 www.daciacarinsurance.co.uk

Lines are open Mon - Thurs 8.30am - 7pm, Fri 9am - 6pm, Sat 9am - 5pm

SERVICING

Dacia Service Plans are the ultimate hassle free way to take care of your vehicle. Depending on the Service plan you purchase (grid below) your servicing needs are covered and you benefit from;

- Inflation Proof Servicing – You know exactly what you'll pay and there are no hidden costs
- Peace of Mind – No matter where life takes you, we'll be there in over 5000 workshops across Europe
- Dacia Expertise & Quality – Our highly trained technicians know your Dacia inside out

The Dacia Service Plan contains Dacia services in-line with the manufacturer's service schedule, plus comes with a complimentary vehicle health check to ensure your Dacia is in the best condition possible.

SERVICE PLAN \wedge	Monthly payments
3 years / 30,000 miles Service Plan	£13.99 per month
3 years / 45,000 miles Service Plan	£21.99 per month
4 years / 48,000 miles Service Plan + 1 MOT	£20.99 per month
4 years / 60,000 miles Service Plan +1 MOT	£24.99 per month

ICE EXTENDED WARRANTY	Total Retail Price
1 years / 100,000 miles \dagger	£415
2 years / 100,000 miles \dagger	£445
3 years / 100,000 miles \dagger	£560
4 years / 100,000 miles \dagger	£690

Dacia Extended warranty ends when you reach the age or mileage limit (whichever comes first). All prices including VAT.

HYBRID EXTENDED WARRANTY	Total Retail Price
1 years / 100,000 miles \dagger	£625
2 years / 100,000 miles \dagger	£715
3 years / 100,000 miles \dagger	£910
4 years / 100,000 miles \dagger	£1,140

Dacia Extended warranty ends when you reach the age or mileage limit (whichever comes first). All prices including VAT.

SERVICE INTERVALS \diamond

Annual servicing **OR** servicing at 18,000 miles (whichever comes first)

Service Schedule \diamond	Year 1	Year 2	Year 3	Year 4	Year 5	Year 6
	Change Cabin Filter	Change Oil + Oil Filter	Change Cabin filter + Brake Fluid	Change Oil + Oil filter + Air filter (36k miles) + Spark Plugs (36k miles)	Change Cabin filter + Coolant (90k miles)	Change Oil + Oil Filter + Brake Fluid + Accessory Belt (90k miles)

*Dacia warranty ends when you reach the age or mileage limit (whichever comes first), from date of registration. Subject to status, terms and conditions apply. For full Dacia Extended Warranty Terms and Conditions visit www.dacia.co.uk/warranty-and-assistance/warranty

Δ Roadside assistance for the first 3 year / 60,000 miles, which ever is reached first, from date of registration. For full Terms and Conditions visit www.dacia.co.uk/warranty-and-assistance/assistance

\dagger Dacia Extended warranties are available to purchase from first date of registration up to end of manufacturer warranty. For full Dacia Extended Warranty Terms and Conditions visit www.dacia.co.uk/warranty-and-assistance/warranty

\wedge The Service plan offer is available for eligible retail vehicles only and valid at participating dealers only. Vehicles must be ordered between 17 December 2024 to 31 March 2025 and registered by 30 June 2025. The Dacia Service plan covers the manufacturer's minimum maintenance programme requirements for the term of the Service plan purchased (refer to the Warranty and Service sheet in the Handover Document wallet for details). The plan ends when you reach the age or mileage limit (whichever comes first). Services must be carried out in line with the manufacturer's minimum maintenance programme requirements and servicing intervals within +/- 1 month or 1,000 miles of the service interval and can only be carried out at a Dacia Approved outlet. Service plans do not cover wear and tear items such as (but not limited to) tyres, wiper blades or brakes. For Service plan full Terms & Conditions visit www.dacia.co.uk/services-and-finance/service-plan. Cannot be part exchanged, refunded or transferred.

\diamond The service schedule / intervals are specific to the version and derivative of vehicle. Check with your Dacia retailer to confirm the service schedule / intervals as the above is an indicative guideline.

1 Dacia Insurance is arranged and administered by Verex Insurance Services Ltd, which is registered in England and Wales No. 05686831 at Batchworth House, Church Street, Rickmansworth, Herts, WD3 1JE and authorised and regulated by the Financial Conduct Authority, No. 487185. Verex Insurance Services Ltd arranges policies from a panel of insurers, details are available on request.

\wedge If your insurer uses non-approved parts which subsequently fail, they may not be covered under your manufacturer's warranty.

DACIA



Every precaution has been taken to ensure that the contents of this brochure were accurate and up-to-date at the time of publication. This document has been produced using pre-production models and prototypes. In line with its policy of continuous product improvement, Dacia reserves the right to modify the specifications, vehicles and accessories described and featured at any time. Any such modifications are communicated to Dacia dealers as quickly as possible. Depending on the country of sale, versions may differ and some equipment may be unavailable (standard, optional or accessory). Please consult your Dacia brand representative for the latest information. Because of the limitations associated with the medium, the colours featured in this document may differ slightly from those of the actual paintwork or interior trim. All rights reserved. Reproduction in any format and by any means of all or part of this brochure is prohibited without prior written authorisation from Dacia.

Dacia recommends  Castrol

PUBLICIS – PHOTO CREDITS : S. STAUB, P. CURTET, ©RENAULT MARKETING 3D-COMMERCE – DECEMBER 2024



[CONFIGURE
AND ORDER](#)

[BOOK A
TEST DRIVE](#)

[FIND YOUR
NEAREST CENTRE](#)

[MENU ^](#)