

DAECIA DUSTER



FOR US, REAL PEOPLE

Dacia Duster goes further: more robust, more outdoor, more technological both on the outside and on board. It goes everywhere with you, whether in your daily life or on your getaways, thanks to its connectivity.



**NEW HYBRID
155 ENGINE**

**UP TO 5 YOUCLIP
ATTACHMENT POINTS**

**10" CONNECTED
TOUCHSCREEN⁽¹⁾**

(1) Standard on Journey and Extreme.

INTERACTIVE MENU

01. DESIGN

02. DRIVING PLEASURE

03. CONNECTIVITY

04. INTERIOR SPACE

**05. DRIVER ASSISTANCE
SYSTEMS**

**06. EQUIPMENT AND
ACCESSORIES**

THE REDESIGNED ICONIC SUV

Dacia Duster continues its success story and increases its versatility with its iconic design and its excellent off-road capabilities. Its Starkle[®] side protectors and wheel arches showcase its powerful SUV nature. Extremely practical for all your adventures, it comes with modular roof bars.



Y-shaped brand light



Heated electric door mirrors

NEW EXPERIENCE INSIDE

For the interior of its flagship SUV, Dacia has focused on ergonomics, design and your well-being on board. The driver has a carefully oriented 10" central display for easy access. The 7" customisable digital instrument panel keeps driving information in sight.



The new design of the steering wheel makes driving comfortable and makes it easier to get on board. In terms of style, the new graphic identity of the Y-shaped headlights is reflected in the door panel armrests and air vents, which come in Copper Brown for the extreme finish and Megalith Grey for the journey version.



In the extreme version, washable MicroCloud plastic-coated fabric upholstery

HIGH-PERFORMANCE HYBRID ENGINES

The Dacia Duster offers something completely new with a full range of mild hybrid and full hybrid engines, such as the 155 hp full hybrid engine coupled with a clutchless automatic gearbox: unrivalled driving pleasure, up to 80% of driving time in all-electric mode in urban areas, and up to 40% fuel savings⁽¹⁾. The battery recharges automatically during deceleration and braking.



Dacia Duster still exists as petrol versions, assisted by an electric system that accompanies the engine when accelerating and starting for more dynamic sensations and limiting your consumption.



(1) Driving in urban environments, compared with an equivalent internal combustion engine.

A MORE DIGITAL AND CONNECTED ON-BOARD EXPERIENCE

Dacia Duster makes your daily life easier with the Media Nav Live multimedia system⁽¹⁾. On its large 10" touchscreen, access navigation with mapping and real-time traffic⁽²⁾. To make your journeys easier, take advantage of wireless smartphone mirroring compatible with Android Auto™ and Apple CarPlay®. You also benefit from practical connected services such as the remote location of the vehicle or the display of information from the on-board computer on your MY Dacia application. You also benefit from the Arkamys® 3D audio system with six speakers that will bring your favourite tracks to life.



(1) Available on Journey and Extreme versions. (2) Included and updates for 8 years.

Android Auto™ is a trademark of Google Inc. Apple CarPlay® is a trademark of Apple Inc.

[CONFIGURE AND ORDER](#)

NEW YOUCLIP ATTACHMENT SYSTEM

With YouClip, you get the smartest multi-purpose fastening system for hanging a wide variety of accessories available in the range. These can be easily clipped to 5 attachment points distributed throughout the passenger compartment and boot. And 2 additional points behind the headrests, available as accessories to extend the system and give you a maximum of 7 YouClip points. For even more comfort, the 3-in-1 YouClip accessory combines a cup holder, lamp and hook, which can be detached and used each in a different location on the vehicle or outside.



The YouClip range offers several other useful accessories: the new YouClip glasses case or the YouClip foldable shopping bag, the YouClip multimedia tablet holder and a YouClip pouch for organising activities on board. These practical YouClip products can be detached and used in different places in the vehicle.



YouClip - multimedia tablet bracket



YouClip - hook

FOR ALL YOUR SPACE NEEDS

Take advantage of a spacious passenger compartment, intelligently designed for your comfort and that of your passengers. Whatever your expectations, its modularity makes it perfectly versatile.



More space with the adjustable roof bars to take everything you want.



OUTDOOR PERSPECTIVES WITH THE InNature RANGE

Every getaway is unique with Duster. Treat yourself to comfortable nights surrounded by nature with the Sleep Pack⁽¹⁾ from the InNature range and its removable double bed measuring 1.90 m long and 1.30 m wide. It can be set up by one person in less than two minutes and is combined at the rear with a retractable table for breakfast, as well as generous storage space of 160 litres in the hybrid version and 175 litres for other engine types.



Don't forget the blackout blinds sold as accessories to block out light and glare. And to make the most of these relaxing moments, the roof awning⁽²⁾ is a new, sturdy and weather-resistant accessory that provides instant shade and shelter, while remaining compact and easy to carry.

For a more spacious base camp, the Dacia hatchback tent connects to your Duster when the boot is open, sleeping up to 3 more people and creating 10 m² of protected space at the rear of the vehicle.

Freedom also means being able to take everything that is useful to you. Choose the exclusive InNature roof rack for Duster. It can be easily attached to the modular roof bars in the transverse position, or to the optional transverse roof bars, which can carry loads of up to 80 kg.



Opaque blackout blinds



Dacia tailgate tent (up to 3 people in the bedroom area)



Roof rack

(1) not available in hybrid-G 150 4x4 version. (2) Supplied with carry bag. Coming soon.

[CONFIGURE AND ORDER](#)

DRIVE IN COMPLETE SAFETY

To complete the range of equipment already on board for your safety and driving comfort, Dacia Duster is equipped with new-generation driver assistance systems. Using the My Safety button you can deactivate some of these assistance systems at any time. With Dacia, peace of mind accompanies you on every journey.

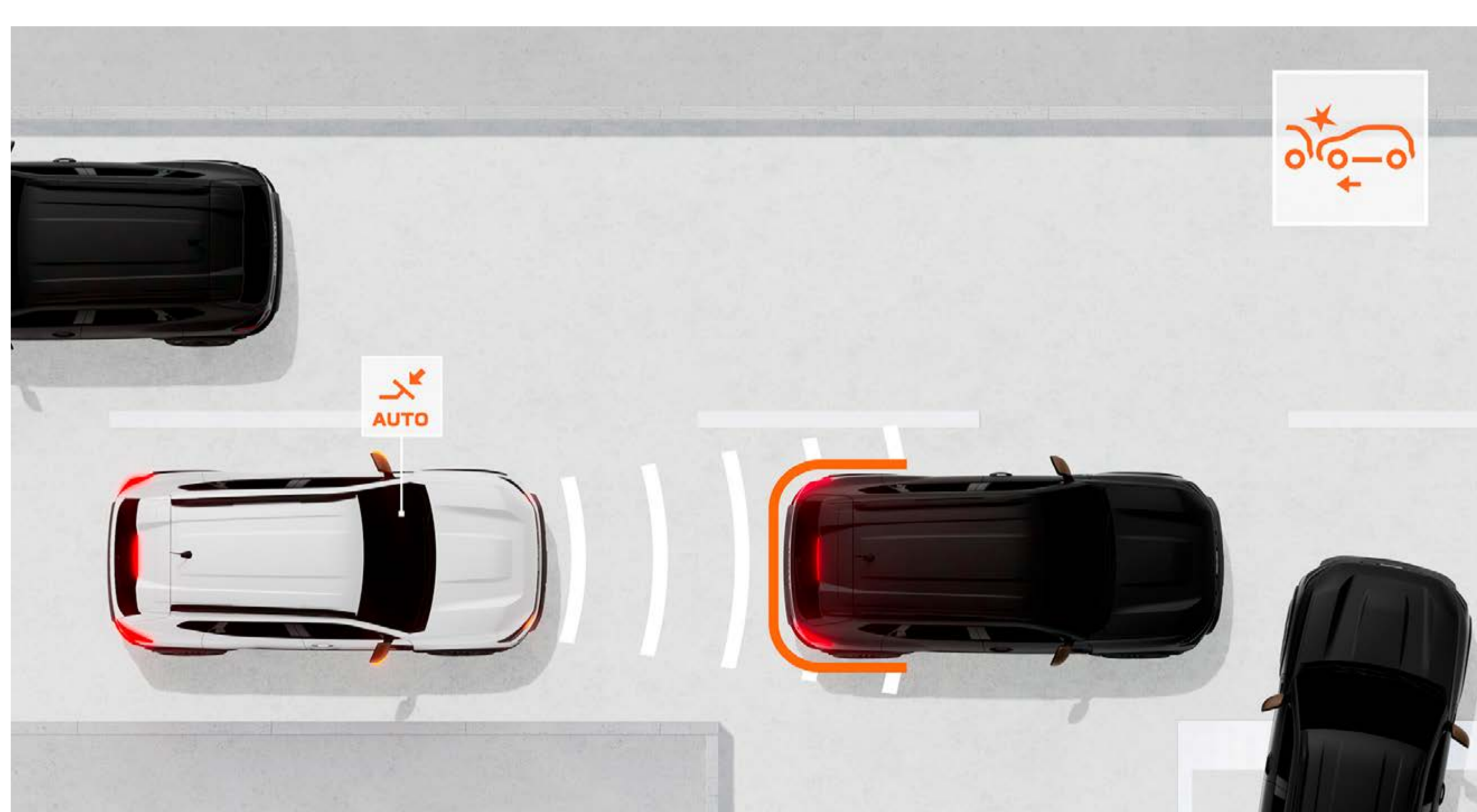

ACTIVE EMERGENCY BRAKING (AEB)

This system prevents the risk of frontal collisions involving other vehicles, pedestrians or cyclists straight ahead and at junctions. It alerts the driver and can automatically brake the vehicle if necessary.

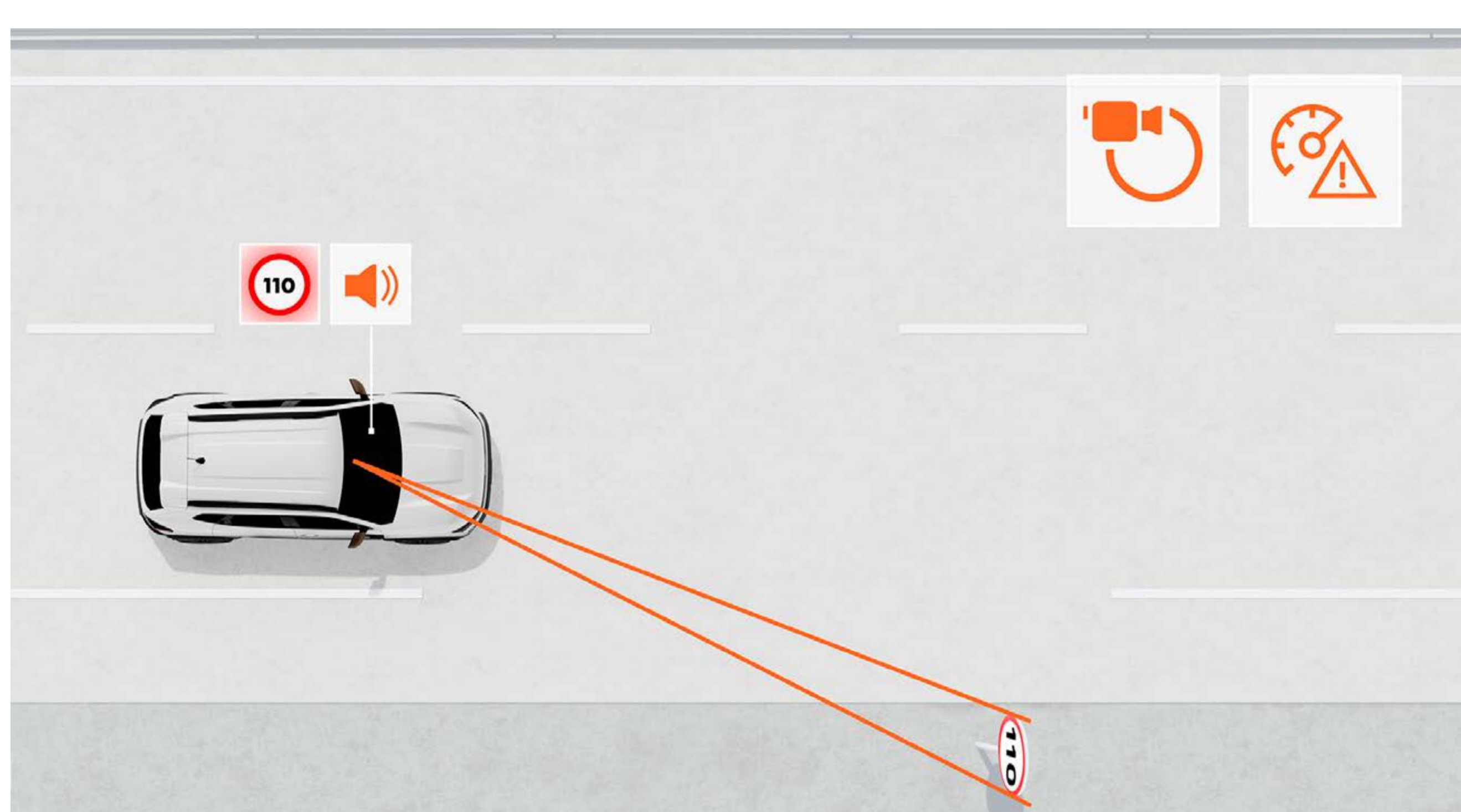

TRAFFIC SIGN RECOGNITION WITH SPEED ALERT

This system provides a reliable real-time indication of the maximum speed on the road and warns the driver if they exceed the speed limit with visual and audible alerts (which can be disabled).

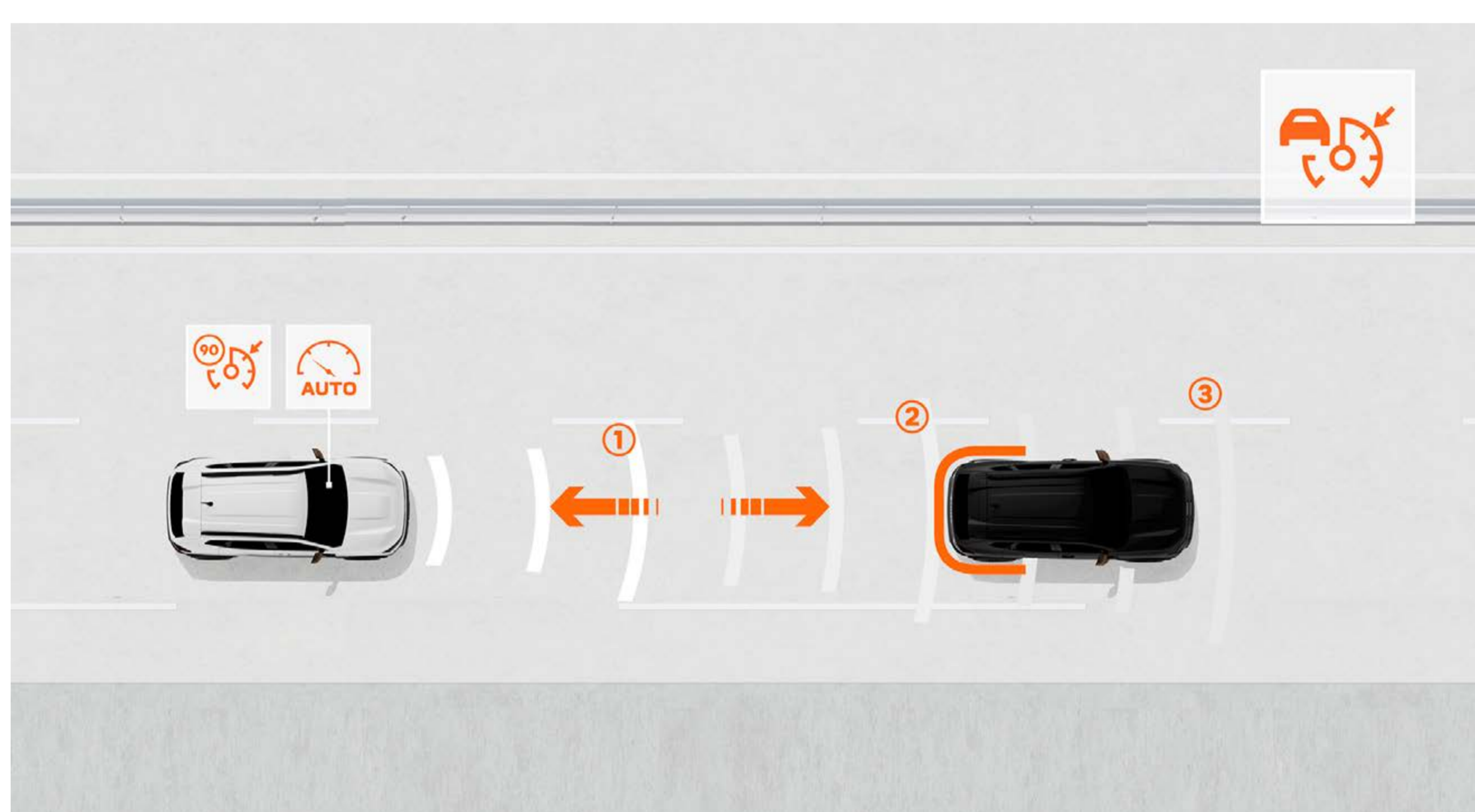

ADAPTIVE CRUISE CONTROL⁽¹⁾

Let cruise control maintain a safe distance from the vehicle in front of you. The brakes are applied if the distance is too short and the car accelerates again when the traffic becomes more fluid.

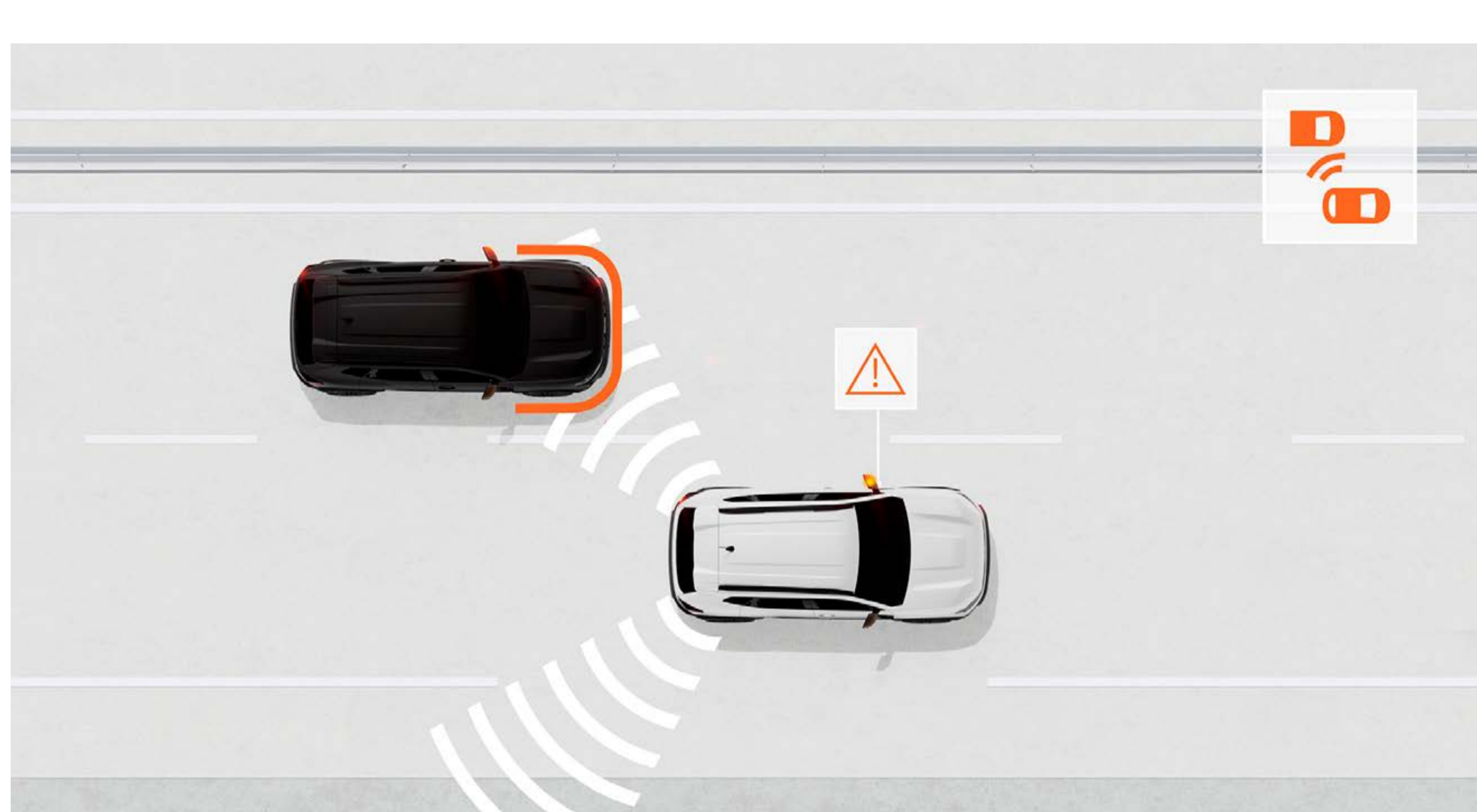

BLIND SPOT WARNING⁽²⁾

This aid monitors the driver's areas of restricted vision to warn them with a visual signal if another vehicle or road user is in the area, allowing them to make lane changes safely.



HILL DESCENT SPEED MONITORING

In steep descents, this system limits the speed taken by the vehicle without having to use the brake pedal.



MULTIVIEW CAMERA⁽²⁾

The MultiView Camera gives you more eyes! It provides front, rear and side views, helping you detect holes, rocks or obstacles that are not always easy to see, and making driving easier for you.

(1) Standard on Journey and Extreme Hybrid versions only. (2) Standard on Journey and Extreme versions.

**FIND OUT MORE
ABOUT THE
FEATURES** 

COLOUR PALETTE

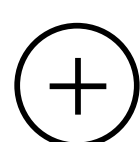

TRIMS

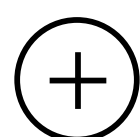

ACCESSORIES

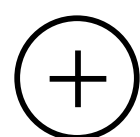

ENGINES

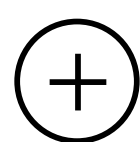

EQUIPMENT AND OPTIONS

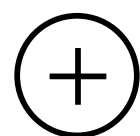

DIMENSIONS

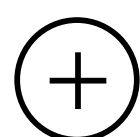

06. COLOUR PALETTE



SANDSTONE⁽¹⁾



DUSTY KHAKI



TERRACOTTA⁽¹⁾



GLACIER WHITE⁽²⁾



SHADOW GREY⁽¹⁾



PEARL BLACK⁽¹⁾



CEDAR GREEN⁽¹⁾

06. TRIMS

expression



MAIN EQUIPMENT

EXTERIOR DESIGN

- 17" Tergan alloy wheels
- Body-coloured exterior door handles
- Megalith Grey door mirrors
- Megalith Grey front and rear skid plates
- Starkle® lower door protection

SAFETY AND DRIVING ASSISTANCE

- Rear-view camera
- Rain sensors

OPTIONS

- Spare wheel and jack
- Metallic or special paint

INTERIOR DESIGN

- Steel Grey air vents
- Special Denim upholstery

ON-BOARD EXPERIENCE

- Front and rear one-touch electric window winders
- Electric parking brake
- 5 YouClip attachment points
- Configurable 7" digital cluster
- Media Display: multimedia system with 10" touch screen, radio, smartphone mirroring via USB cable or wireless via Wi-Fi, Bluetooth® telephone system, 4 speakers and remote services pack
- Centre console with armrest and storage compartment

journey



MAIN EQUIPMENT

journey = expression+

EXTERIOR DESIGN

- 18" Tagasan alloy wheels
- Front fog lights
- Tinted windows (rear, quarter panels, tailgate)

INTERIOR DESIGN

- Specific fabric upholstery for journey version

ON-BOARD EXPERIENCE

- Automatic heating and air conditioning system
- Auto-fold door mirrors with control panel on driver's door
- Hands-free card
- Wireless charger
- Electric parking brake
- Media Nav Live: multimedia system with 10" touchscreen, connected navigation with automatic map update for 8 years, radio, smartphone mirroring via USB cable or wireless via Wi-Fi, Bluetooth® connection, 6 speakers, Arkamys 3D sound®, Dacia app store and Remote Services pack
- Driver's seat with lumbar adjustment

SAFETY AND DRIVING ASSISTANCE

- Automatic main/dipped beam headlight activation
- Adaptive cruise control (Standard on hybrid 155 engine only)
- Multi view camera
- Blind spot warning
- Front and side parking sensors

OPTIONS

- Spare wheel and jack
- Metallic or special paint

extreme



MAIN EQUIPMENT
extreme = journey +

EXTERIOR DESIGN

- 18" Tagasan semi-diamond cut alloy wheels
- Copper brown door mirror shells
- Modular roof bars
- Front fog lights

INTERIOR DESIGN

- MicroCloud plastic-coated textile upholstery
- Front door inserts in washable MicroCloud plastic-coated textile fabric with Copper Brown topstitching
- Copper Brown details on air vents

ON-BOARD EXPERIENCE

- Automatic heating and air conditioning system
- Electric parking brake
- Auto-fold door mirrors with control panel on driver's door
- Hands-free card
- Rubber boot mat
- Screen-printed front and rear rubber floor mats
- Driver's seat with lumbar adjustment
- Height-adjustable passenger seat

- Media Nav Live: multimedia system with 10" touchscreen, connected navigation with automatic map update for 8 years, radio, smartphone mirroring via USB cable or wireless via Wi-Fi, Bluetooth® connection, 6 speakers, Arkamys 3D sound®, Dacia app store and Remote Services pack
- Centre console with armrest and storage compartment
- Heated front seats
- Heated steering wheel

SAFETY AND DRIVING ASSISTANCE

- Automatic main/dipped beam headlight activation
- Downhill speed control (on 4x2 versions)
- Multi view camera
- Blind spot warning
- Front parking and side parking sensors
- Adaptive cruise control (hybrid version only)

OPTIONS

- Spare wheel and jack
- Metallic or special paint

CONFIGURE AND ORDER

06. ACCESSORIES

STYLE PACK



Shark antenna

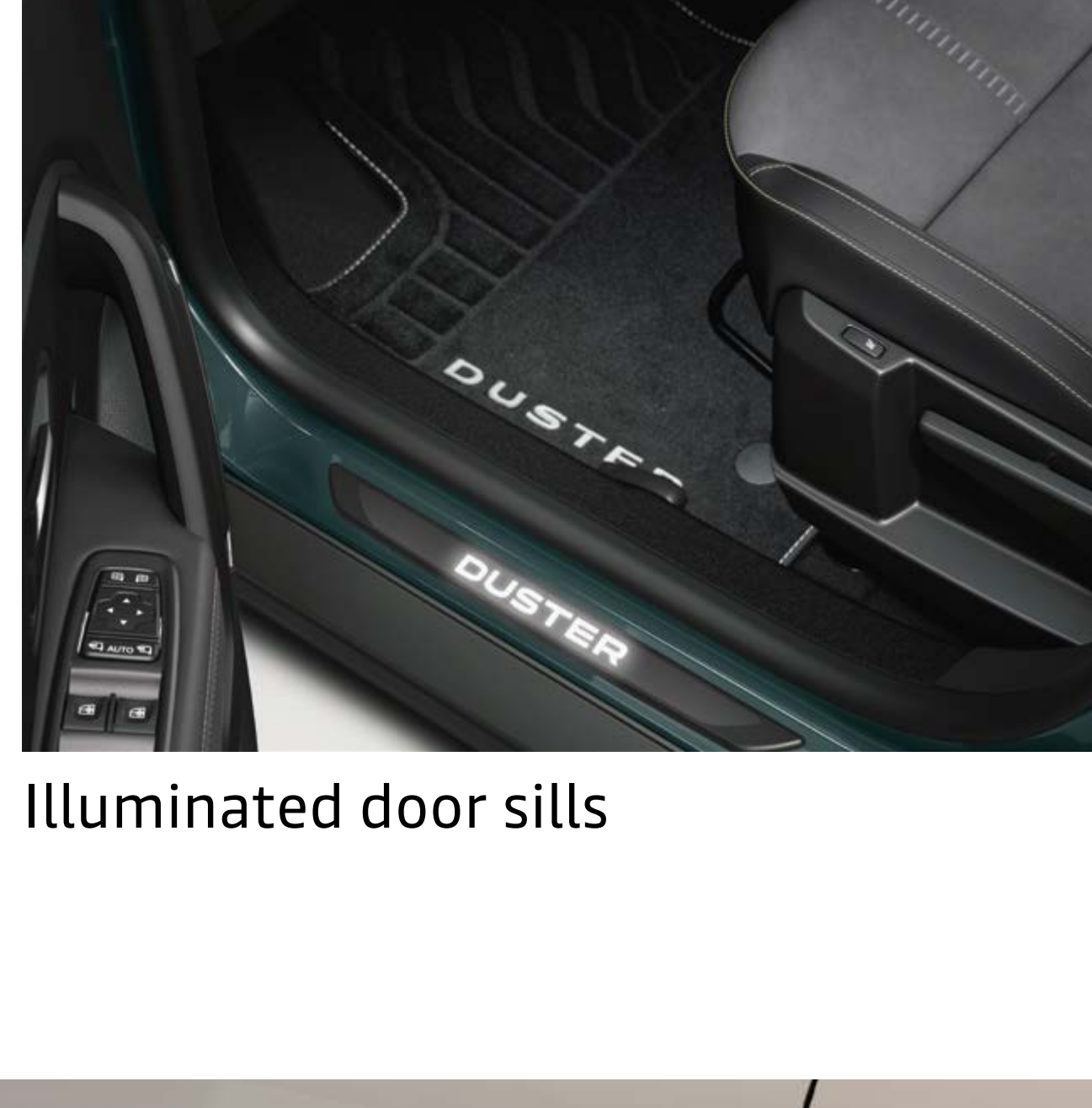

Illuminated door sills

SIDE STEP PACK

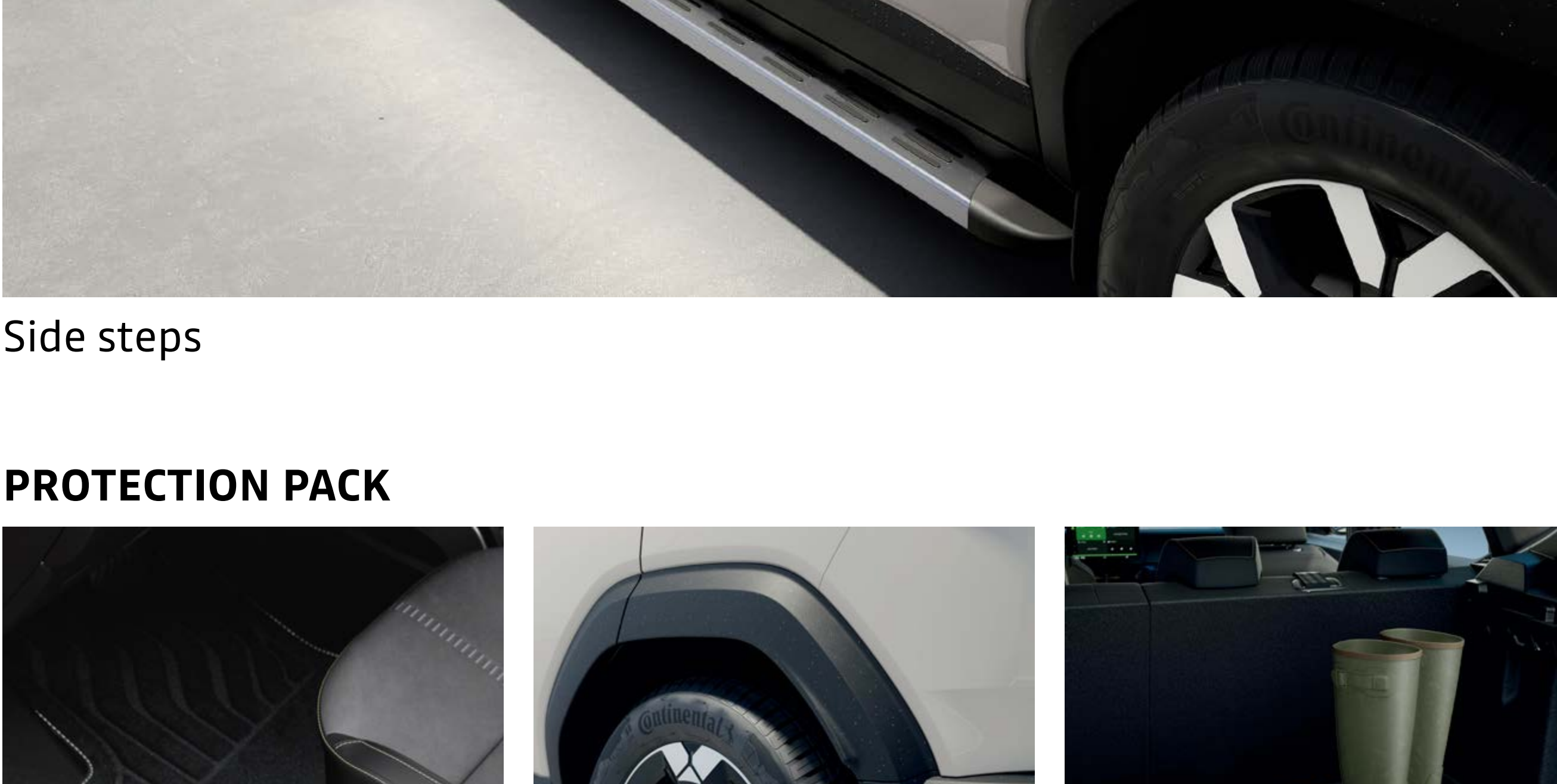

Side steps

PROTECTION PACK

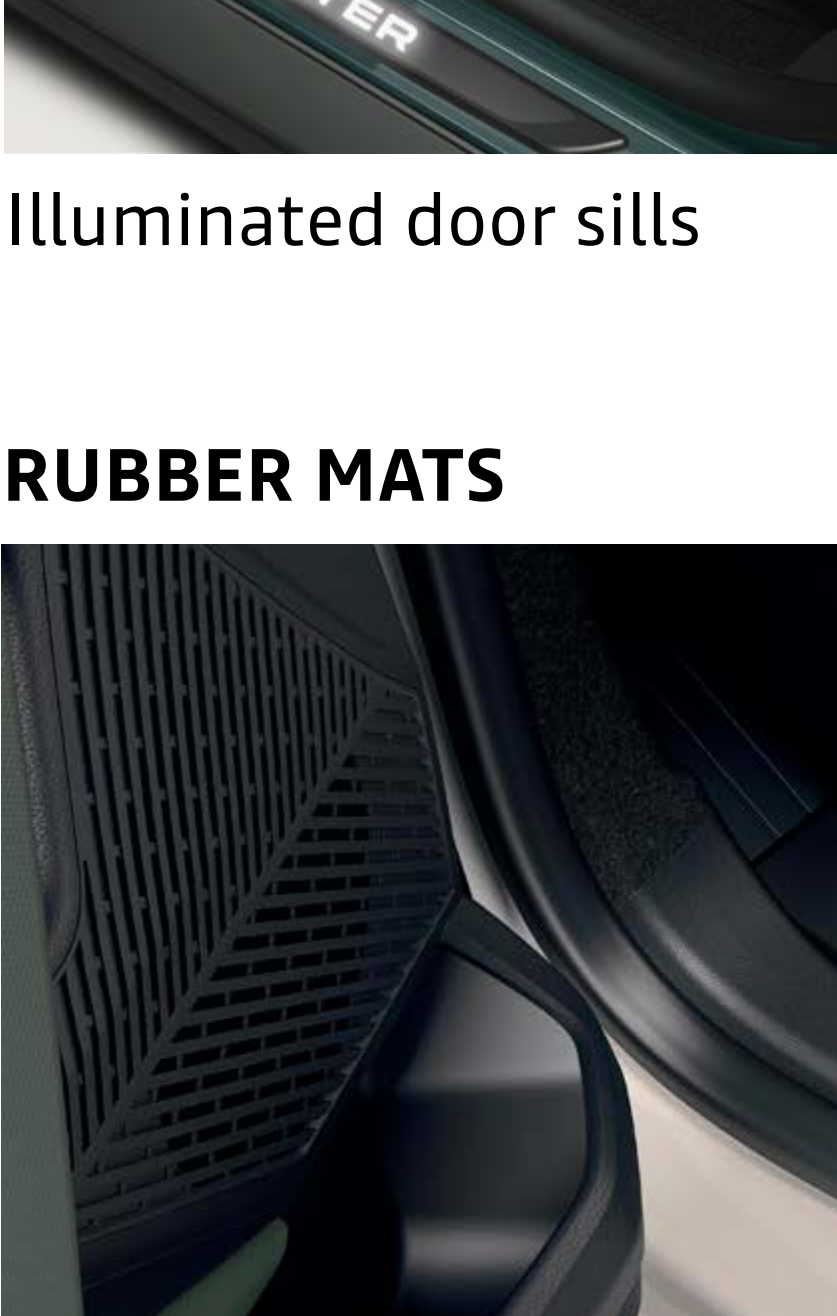

Illuminated door sills



Front & rear mud guards

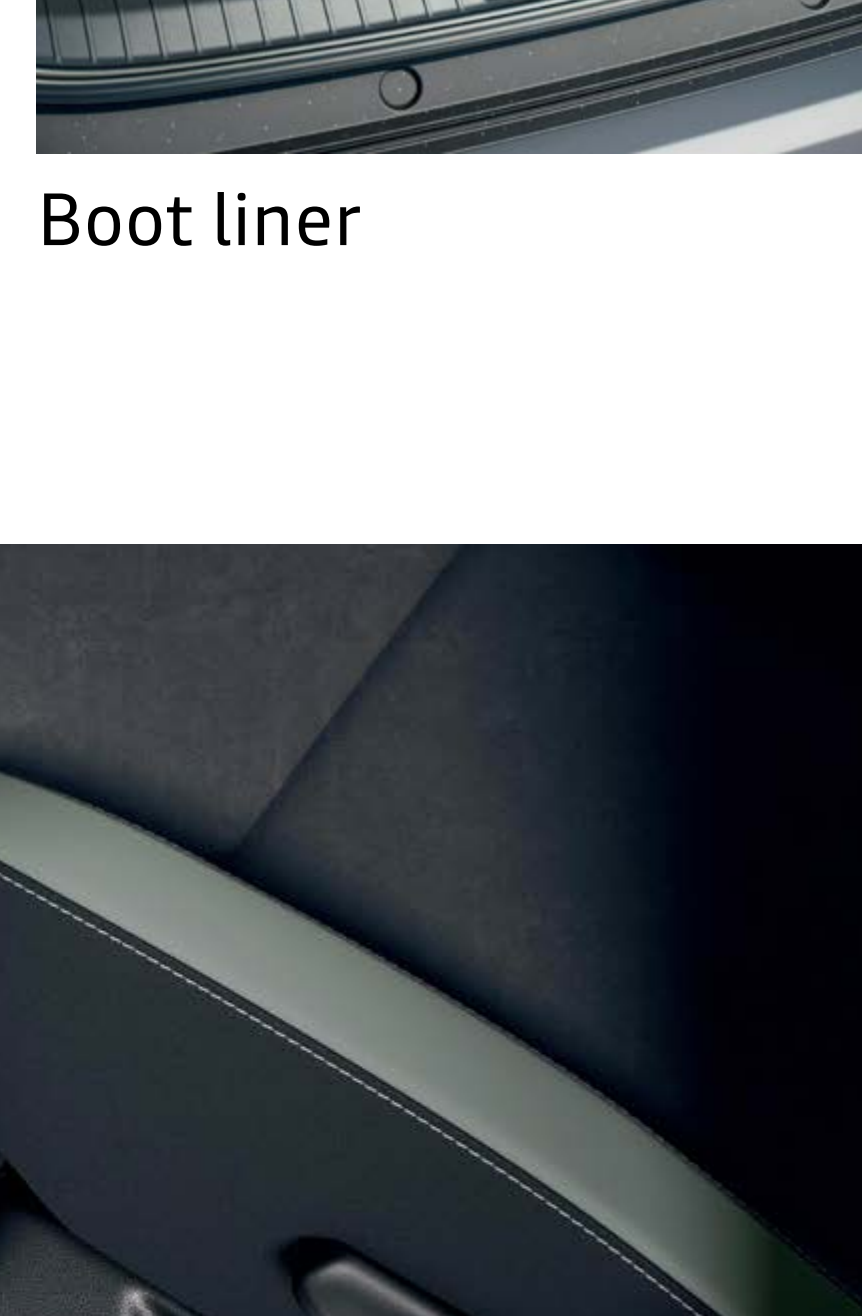

Boot liner

RUBBER MATS



DASH CAM PACK



Front and rear dashcam

TOURING PACK

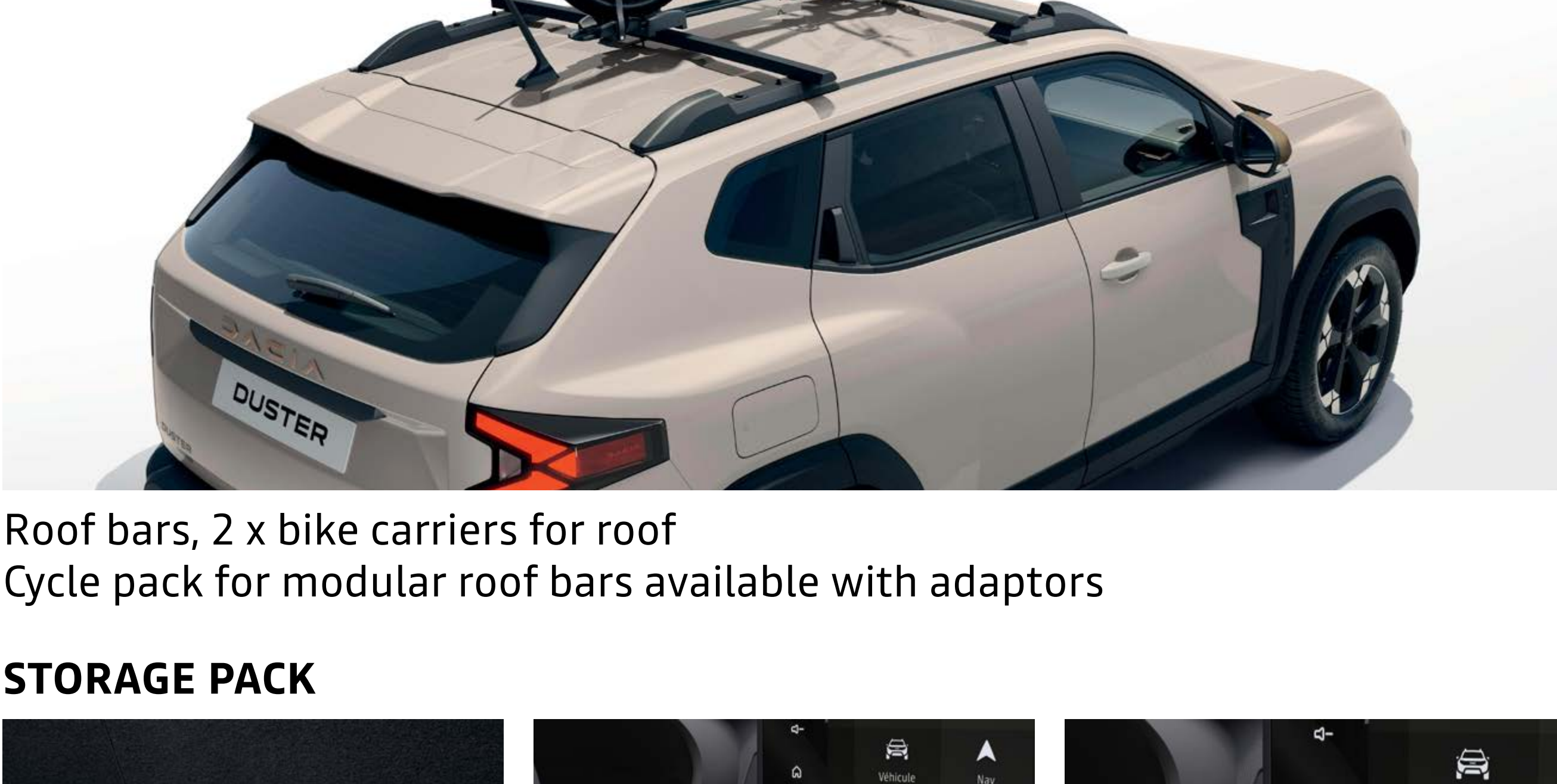

Roof bars, Roof box 480L

CYCLE PACK

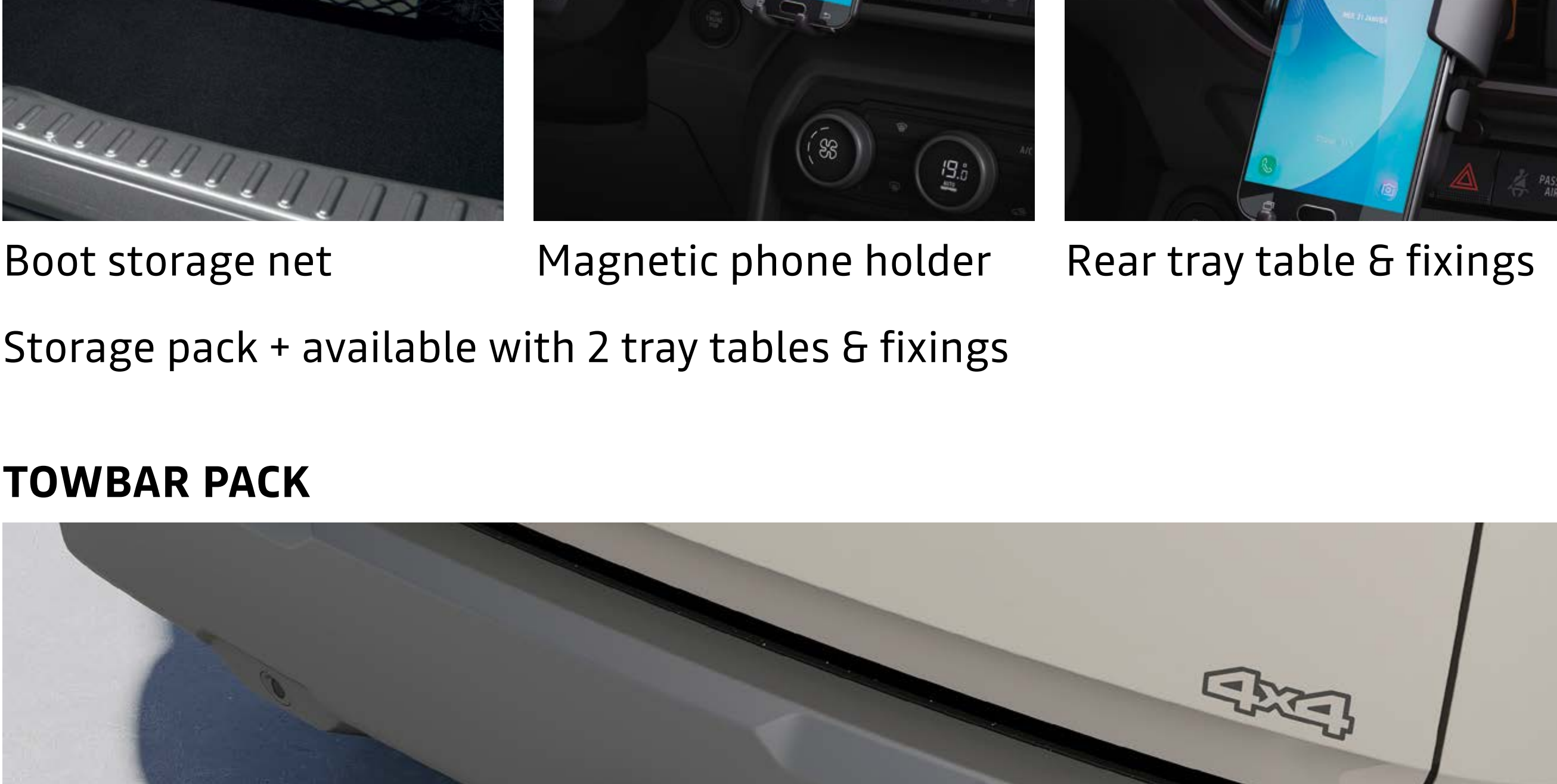

Roof bars, 2 x bike carriers for roof
Cycle pack for modular roof bars available with adaptors

STORAGE PACK



Boot storage net



Magnetic phone holder



Rear tray table & fixings

Storage pack + available with 2 tray tables & fixings

TOWBAR PACK

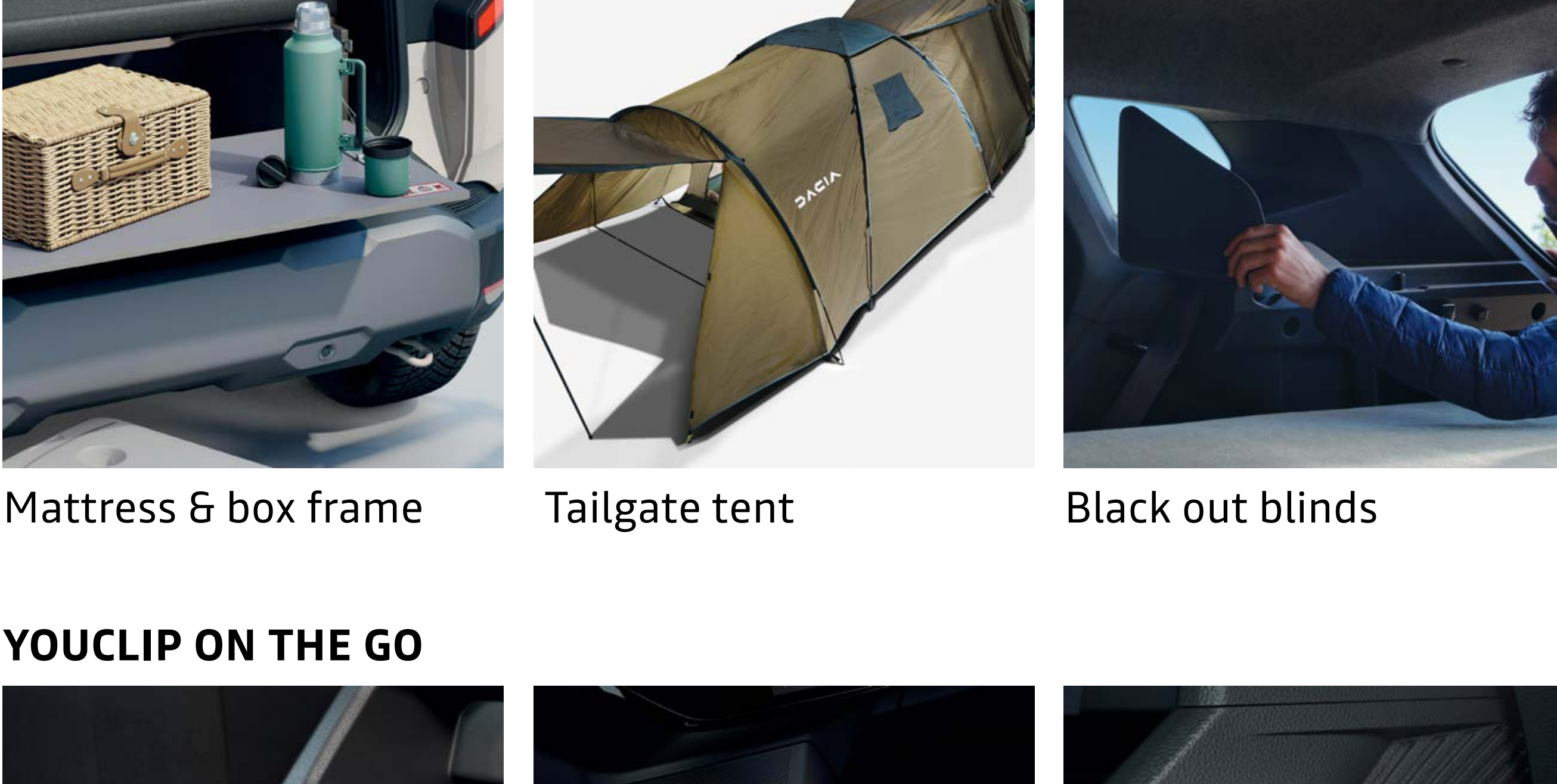

Swan neck towbar 13 pin
Removable towbar 13 pin

IN NATURE ROOF RACK

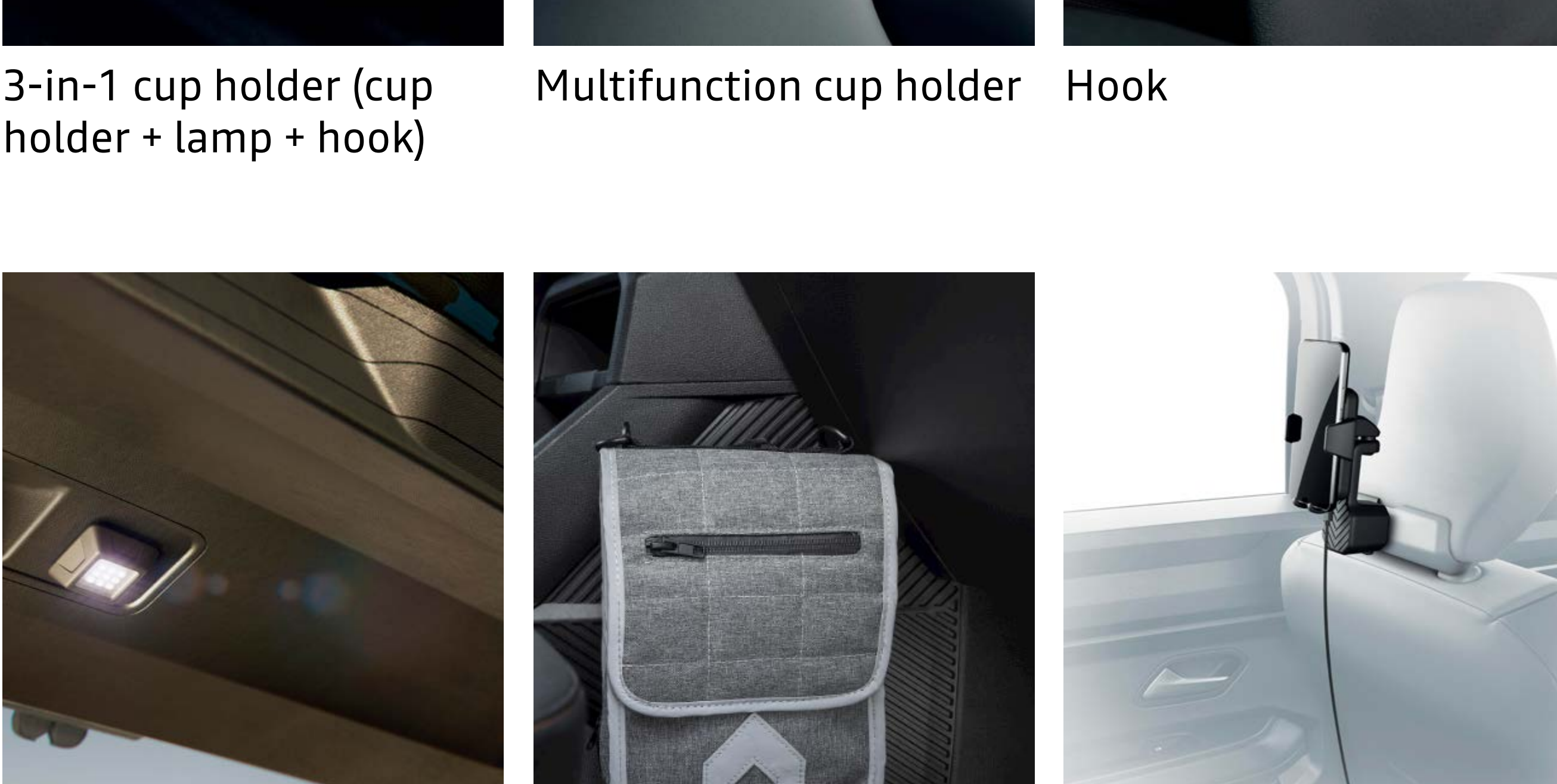

IN NATURE ULTIMATE PACK

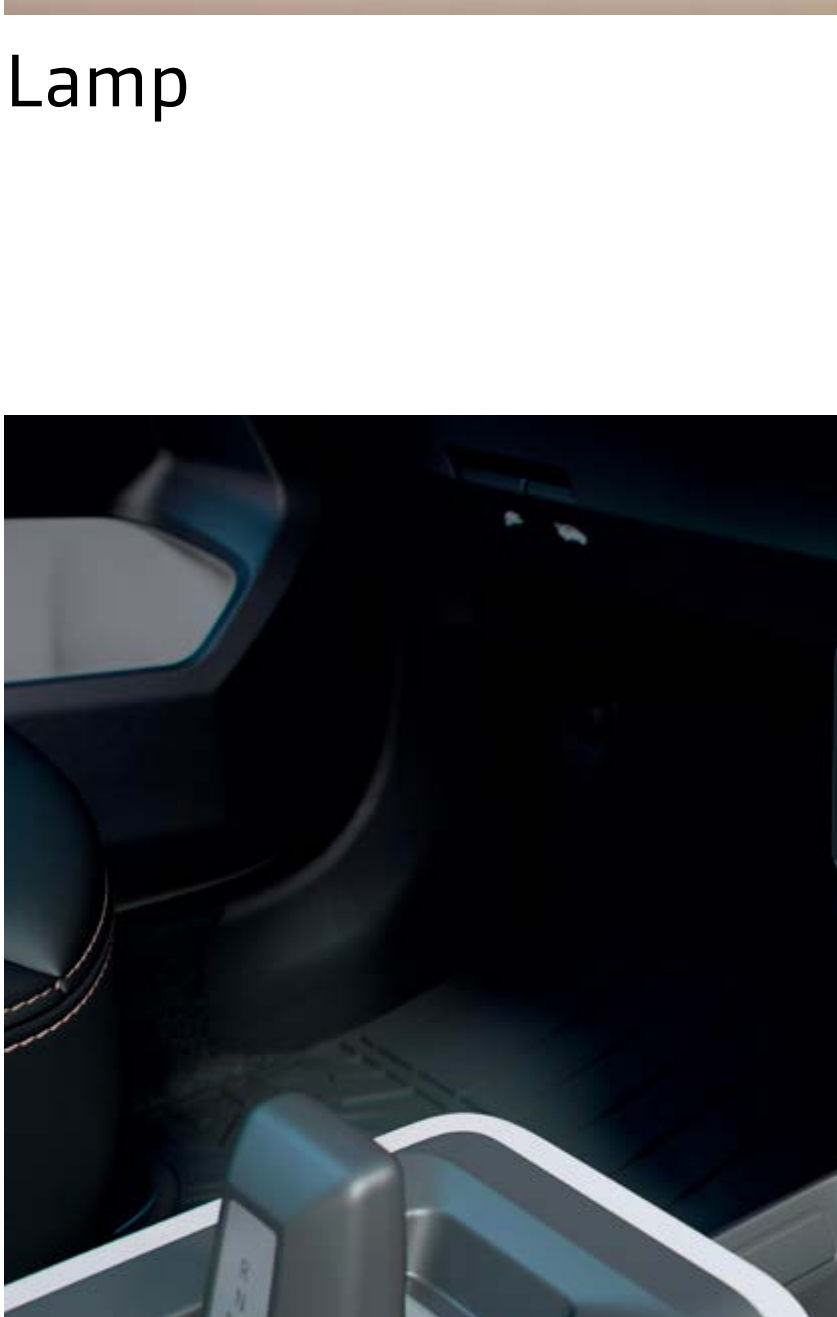

Mattress & box frame



Tailgate tent



Black out blinds

YOUCLIP ON THE GO



3-in-1 cup holder (cup holder + lamp + hook)



Multifunction cup holder



Hook

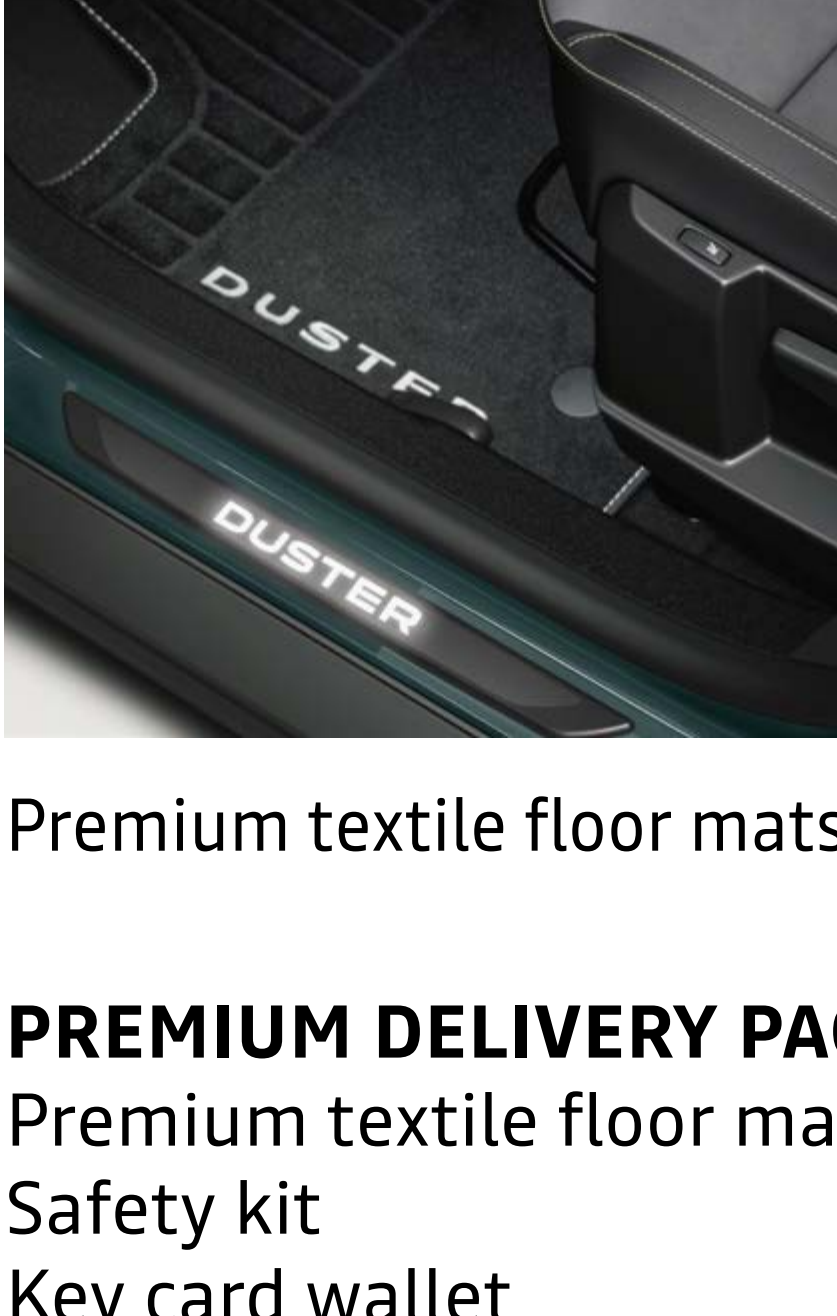

Lamp



Bag

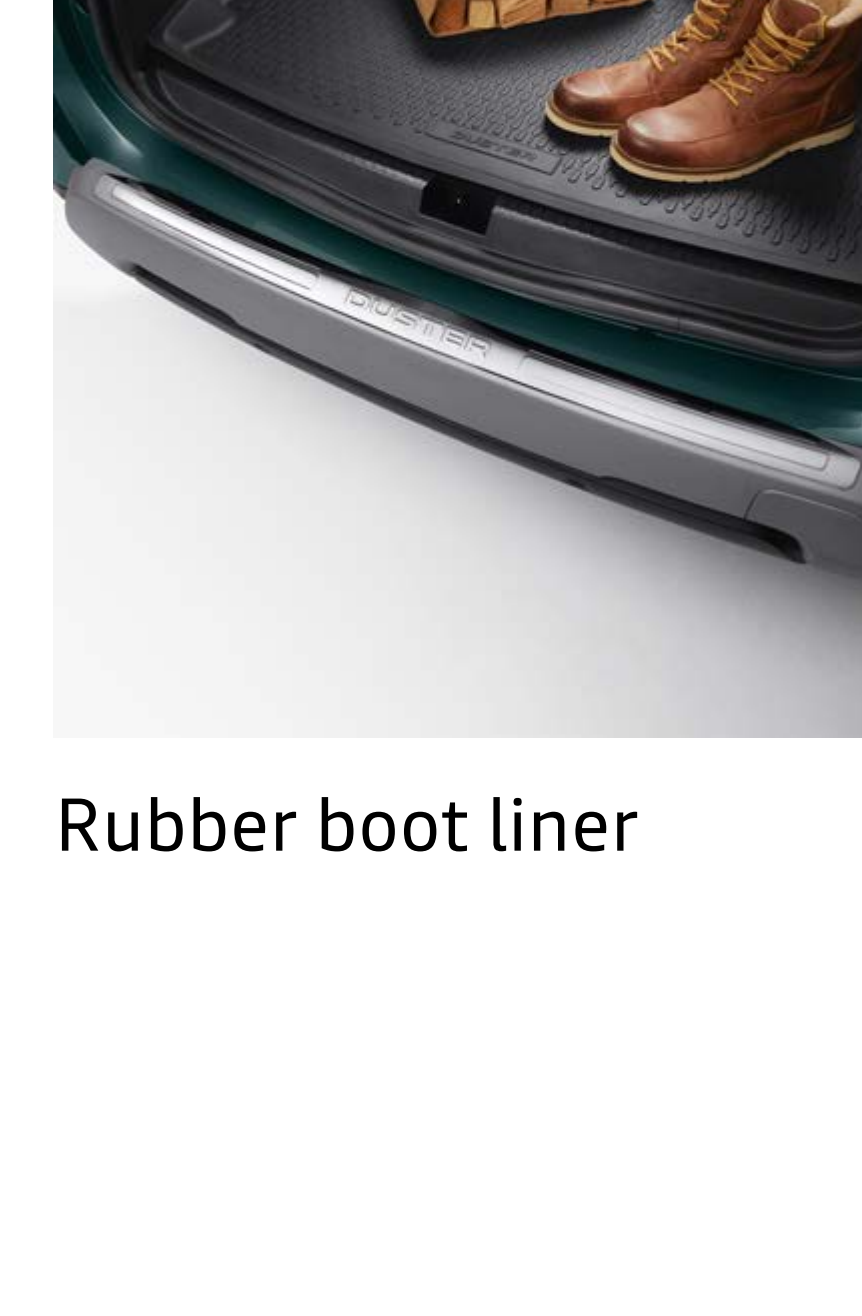

Wireless smartphone charger

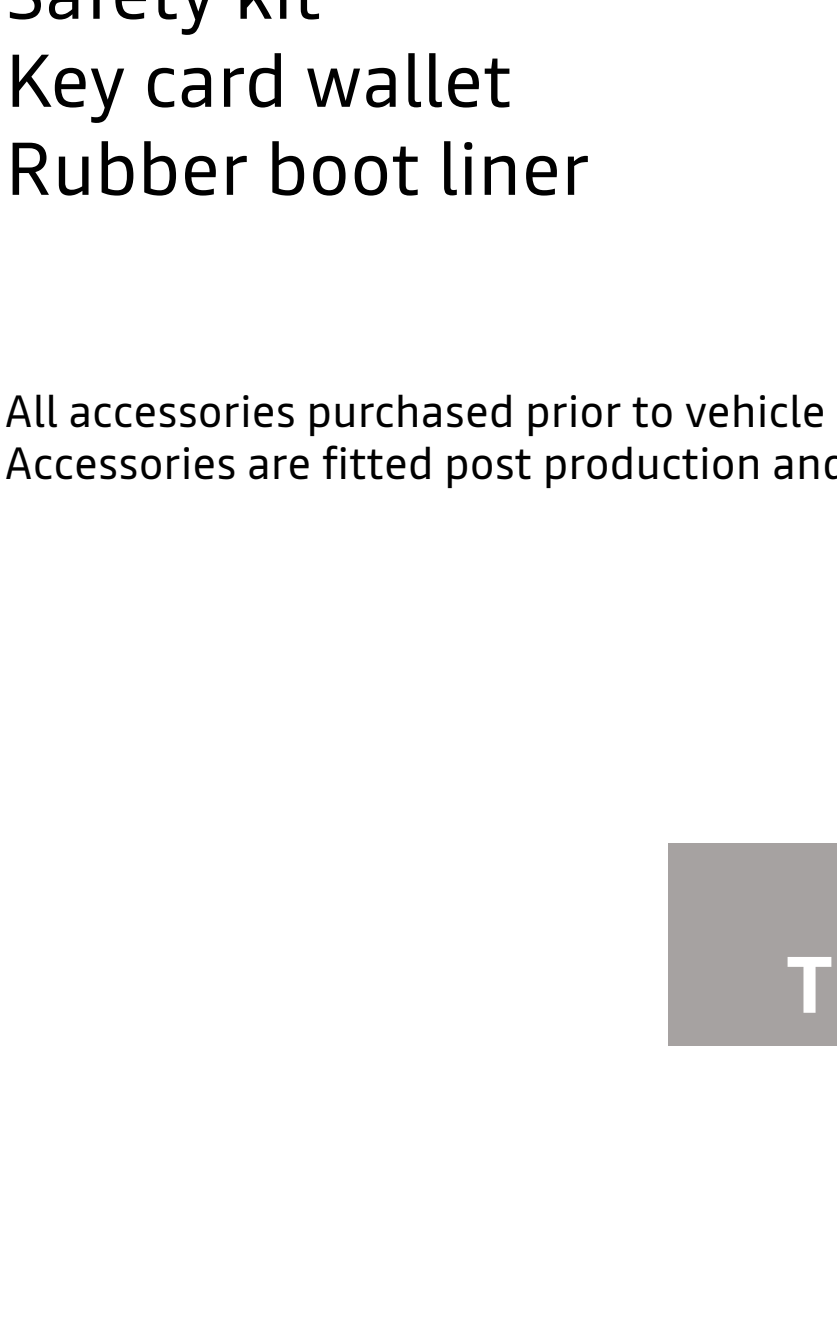

Smartphone holder



Tablet holder



Headrest base mount



Foldable shopping bag



Glasses case

PREMIUM DELIVERY PACKS

Premium textile floor mats

Safety kit

Rubber boot liner

PREMIUM DELIVERY PACK

Premium textile floor mats

Safety kit

Key card wallet

PREMIUM DELIVERY PACK+

Premium textile floor mats

Safety kit

Key card wallet

Rubber boot liner

All accessories purchased prior to vehicle registration come with a 3 year manufacturers warranty
Accessories are fitted post production and may have an impact on WLTP fuel (actual) consumption and CO₂ figures

DOWNLOAD
THE ACCESSORIES BROCHURE

06. ENGINES

	mild hybrid 140	155 hybrid
ENGINES		
Energy	Petrol / Electric mild hybrid 48V	Petrol / Electric full hybrid 280 V
Driving in full electric mode	-	Yes
Max. power kW EEC (hp) at an engine speed of (rpm)	103 (140 hp) at 4,500-5,500	116 (155 hp) cumulative at 5,300*
Max torque N.m EEC (m.kg) at an engine speed of (rpm)	230 at 2,100-3,500	172 (combustion) / 205 (elec.) not cumulative at 3,000
Injection type	Direct injection	Direct injection
Capacity (cm ³)	1,199	1,789
Number of cylinders/valves	3 cylinders/ 12 valves	4 cylinders/ 16 valves
Emission control standard	Euro 6E bis	Euro 6E bis
Particulate filter(1)	Yes	Yes
Stop & Start(2)	Yes	Yes
BATTERIES		
Traction battery	Lithium-ion / 48 V / 0.84kWh	Lithium-ion / 280 V / 1.4kWh
PERFORMANCE		
Maximum speed (km/h)	112	112
0-62 mph (s)	9.4	9.4
GEARBOX AND TRANSMISSION		
Transmission	4x2	4x2
Gearbox type /number of gears	Manual/6	Multimode automatic/4+2
STEERING		
Steering	Electrical power-assisted steering	Electrical power-assisted steering
Turning circle, kerb to kerb (m)	10.96	10.96
BRAKING		
Front: ventilated disc (VD)/diameter (mm)	280 x 24	296 x 26
Rear: drum (D)/diameter (inches)	280 x 9.6	280 x 9.6
WHEELS AND TYRES		
Standard tyre size	Expression 17 " Journey and Extreme 18"	Expression 17 " Journey and Extreme 18"
FUEL CONSUMPTION AND EMISSIONS(3)		
Approval protocol	WLTP(4)	WLTP(4)
Eco mode	Yes	Yes
Fuel tank capacity (l)	50	50
CO ₂ emissions (g/miles)	123	106-107
Consumption over a combined cycle (mpg)	52.3	60.1- 61.4
WEIGHTS (KG) AND VOLUMES (DM³ OR LITRES)		
Max. unladen kerb weight	1,376	1,454
Gross train weight (GTW)	3,330	2,655
Gross vehicle weight (GVW)	1,830	1,905
Max./min. payload(5)	454/528	451/525
Max. braked towing weight	1,500	750
Max. unbraked towing weight	685	725
Max. boot volume under luggage space cover with repair kit/with spare wheel(6) (dm ³ VDA)	517/474	430/349
Max. boot capacity, rear bench seat folded down with repair kit/with spare wheel(6) (dm ³ VDA)	1,609/1,566	1,545/1,415
Max. boot volume under luggage space cover with repair kit/with spare wheel (litres)	594/545	496/401
Max. boot volume with rear bench seat folded down with repair kit/with spare wheel (litres)	1,696/1,653	1,609/1,528

(1) Petrol engines with particle filter (DPF): to reduce particle emissions, the new direct injection petrol engines now include a particle filter in the exhaust line. The filter removes particles in the exhaust gases, then burns them using automatic and very regular regeneration. The particle filter requires no maintenance. (2) The vehicle's starter and battery are adjusted for use with the Stop & Start system. (3) Official consumption and emissions according to applicable regulations. (4) WLTP (Worldwide Harmonised Light Vehicle Test Procedures): this new protocol provides results much closer to those found in daily use compared with the NEDC protocol. Fuel consumption and CO₂ emissions are certified using a standard, regulatory method. This method is identical for all manufacturers and enables vehicles to be compared. (5) The payload indicated is for the lowest equipment level. (6) According to ISO standard 3832. * Combined power of combustion and electric engines.

06. EQUIPMENT & OPTIONS

	expression	journey	extreme
EXTERNAL APPEARANCE			
LED brand light	•	•	•
Automatic activation of daytime running lights	•	•	•
Grille with white hubcaps	•	•	•
Front and rear skid plates	Megalith Grey	Megalith Grey	Megalith Grey
Exterior door handles	Body-coloured	Body-coloured	Body-coloured
Door mirrors	Megalith Grey	Megalith Grey	Copper Brown
Roof bars	Black	Black	-
Modular roof bars	-	-	Black
Tinted windows (rear, quarter panels, tailgate)	-	•	•
17" Tergan alloy wheels	•	-	-
18" Tagasan diamond-cut alloy wheels	-	•	-
18" Tagasan semi-diamond-cut alloy wheels	-	-	•
SEATS AND INTERIOR TRIMS			
Air vent surrounds	Steel Grey	Steel Grey	Copper Brown
Interior door handles	Steel Grey	Steel Grey	Steel Grey
Front door pull handles	Megalith Grey Satin	Megalith Grey Satin	Khaki
Folding rear bench 1/3 & 2/3	•	•	•
Soft feel steering wheel	•	•	•
Specific fabric upholstery for essential version	-	-	-
Specific Denim upholstery	•	-	-
Specific fabric upholstery for journey version	-	•	-
MicroCloud plastic-coated textile upholstery	-	-	•
ACTIVE AND PASSIVE SAFETY			
Adaptive cruise control	-	• (hybrid only)	• (hybrid only)
6 airbags (driver and passenger front, curtain and side airbags)	•	•	•
Anti-lock brake system (ABS)	•	•	•
Automatic emergency braking with pedestrian/cyclist detection (AEBS)	•	•	•
Lane keeping assist (LKA)	•	•	•
Lane departure warning system (LDWS)	•	•	•
Driver drowsiness and attention warning system (DDAW)	•	•	•
Traffic sign recognition with intelligent speed adaptation (ISA)	•	•	•
Emergency Brake Assist (EBA)	•	•	•
Automatic headlighting	•	•	•
Emergency call (E-call)	•	•	•
My Safety button to easily manage driver assistance systems ⁽³⁾	•	•	•
Front / rear "Rescue Code®" QR Codes	•	•	•
Electronic Stability Control (ESC) ⁽¹⁾ with Hill Start Assist (HSA)	•	•	•
Front and rear seat belts with pyrotechnic pretensioner	•	•	•
Tyre pressure detection	•	•	•
3rd rear 3-point seat belt (inertia reel)	•	•	•
Spare wheel + jack ⁽²⁾	○	○	○
Tyre inflation kit	•	•	•
Isofix child seat mounting system on rear side seats	•	•	•
Electric parking brake	•	•	•
DRIVING AND CONTROL INSTRUMENTS			
Electrical power steering	•	•	•
YouClip – smartphone bracket	-	•	•
Configurable 7" digital instrument panel and 13-function on-board computer	•	•	•
Visual and audible front seat belt warning	•	•	•
Eco Mode (FOR EURO 6 COUNTRIES to be adapted) + Stop & Start + gear change indicator	•	•	•
Hill descent control system (on 4x4 + for extreme 4x2 and 4x4 versions)	-	-	•
Cruise control and speed limiter	•	•	•
Rear parking sensors	•	•	•
Front and side parking sensors	-	•	•
Rear-view camera	•	•	•
Multiview camera	-	•	•

•: available as standard; ○: available as an option; -: not available. (1) Disconnectable only on 4x4 versions. (2) The "spare wheel + jack" option replaces the "tyre inflation kit". (3) For configurable driving aids.

VISIBILITY

Front fog lights	-	•	•
Heated rear screen/timed rear screen wiper	•/•	•/•	•/•
Heated electric door mirrors	•	•	•
Rain sensors	•	•	•

COMFORT

Manual heating and air conditioning system	•	-	-
Automatic heating and air conditioning system	-	•	•
Automatic folding door mirrors	-	•	•
Electric door locking with radio frequency remote	•	•	•
Hands-free card	-	•	•
Front electric windows	•	•	•
Electric rear windows	•	•	•
Height and depth- adjustable steering wheel	•	•	•
Height-adjustable driver's seat	•	•	•
Driver's seat with lumbar adjustment	-	•	•
Height-adjustable passenger seat	•	•	•
Semi-high centre console with armrest and storage compartment	•	•	•
2 USB-C sockets in the rear of the console	•	•	•
Front reading spotlight	-	-	-
2 front reading spotlights	•	•	•
1 reading light for rear passengers	-	•	•
12V sockets front/rear	•/•	•/•	•/•
Boot lighting	•	•	•
Wireless charger	-	•	•

MULTIMEDIA & AUDIO

Media Display: multimedia system with 10" touchscreen, DAB digital radio, smartphone mirroring via USB cable or wireless via Wi-Fi, Bluetooth® connection, satellite controls on steering wheel, 4 speakers and remote services pack (see Connected services)	•	-	-
Media Nav Live: multimedia system with 10" touchscreen, connected navigation with automatic map updates, real-time traffic info and danger zones for 8 years (including mobile licence and data), DAB digital radio, smartphone mirroring via USB cable or wireless via Wi-Fi, Bluetooth® connection, satellite controls on steering wheel, 6 speakers, Arkamys 3D sound®, Dacia app store and remote services pack (see Connected services)	○	•	•

CONNECTED SERVICES

Remote services pack (via the MY Dacia application) included for 8 years: find my vehicle (remote geolocation on map, my dashboard data (mileage travelled, remaining driving range)	•	•	•
FOTA (Firmware Over The Air): for installing software patches and improvements directly to the car, without the need for dealer intervention (up to 5 years)	•	•	•

•: available as standard; ○: available as an option; -: not available. (1) Disconnectable only on 4x4 versions. (2) The "spare wheel + jack" option replaces the "tyre inflation kit". (3) For configurable driving aids.

CONFIGURE AND ORDER

06. DIMENSIONS

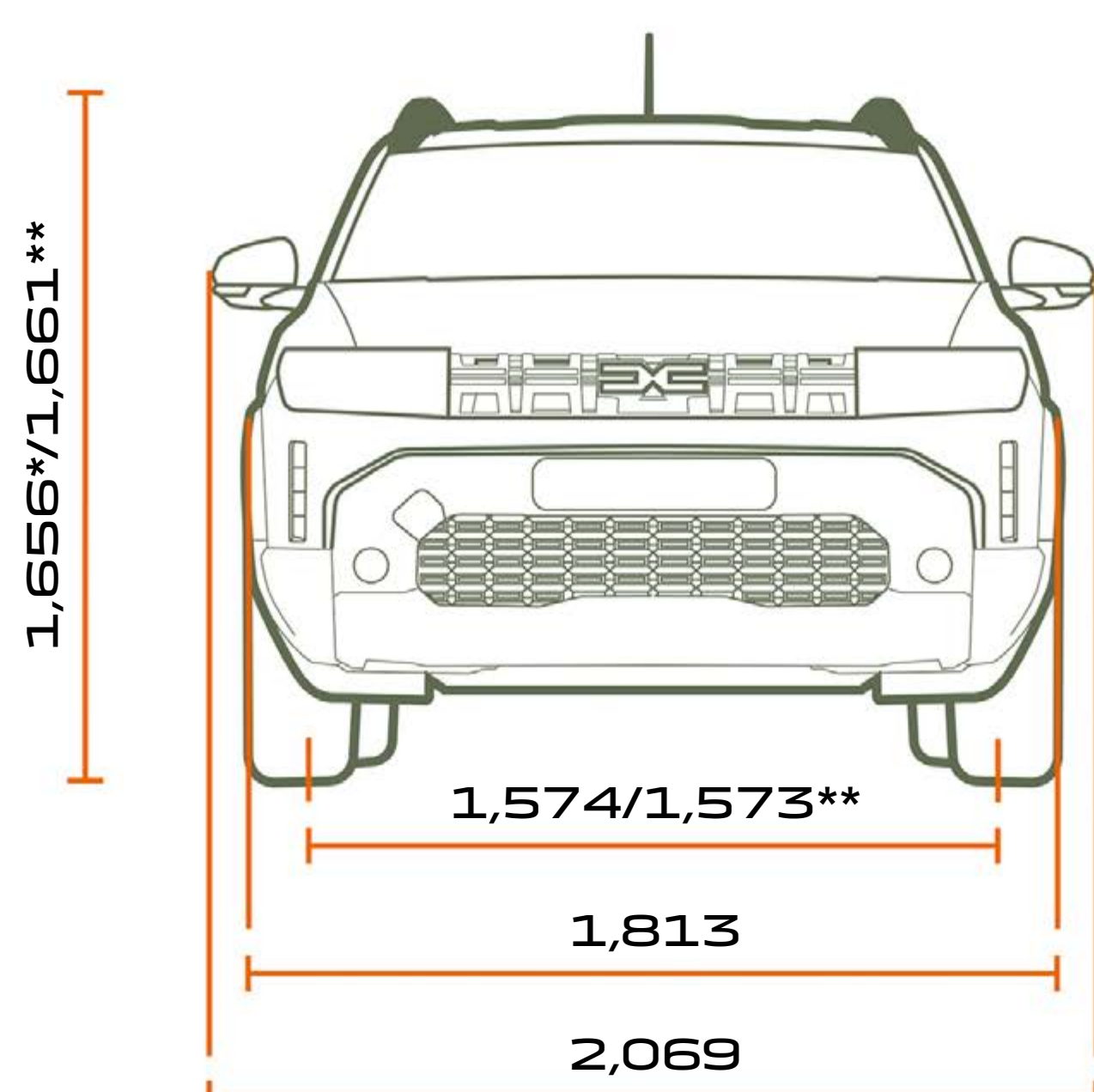

FRONT VIEW

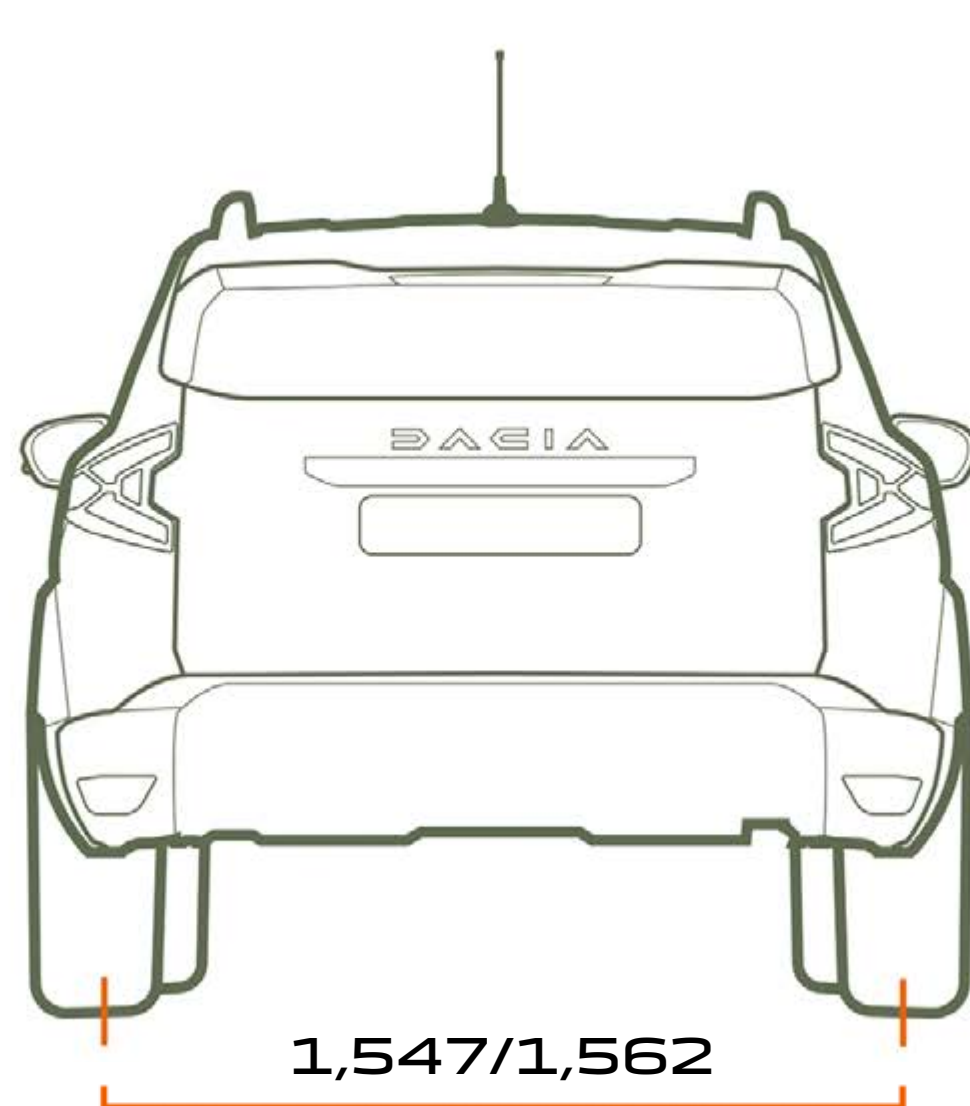

REAR VIEW

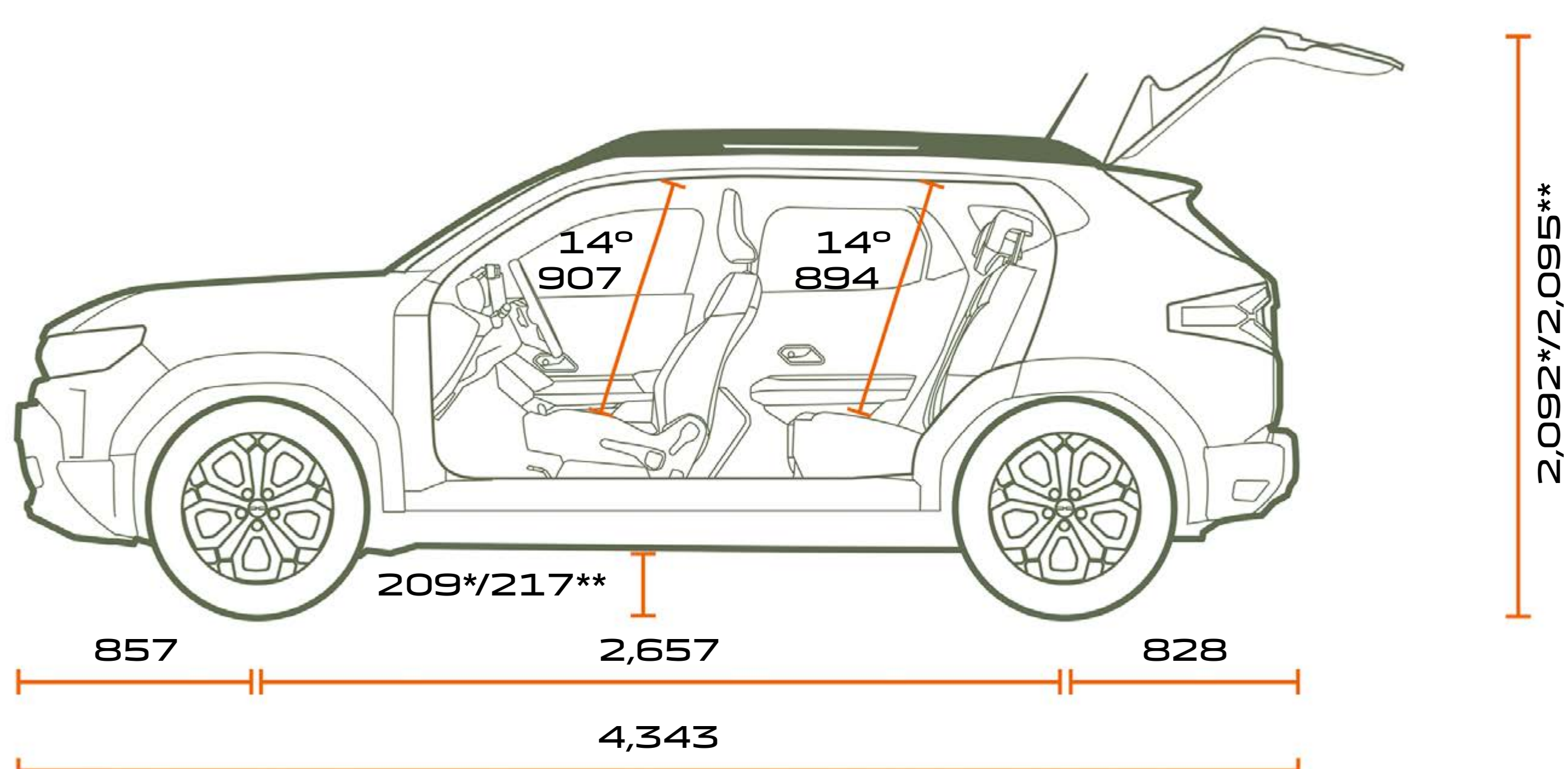

SIDE VIEW

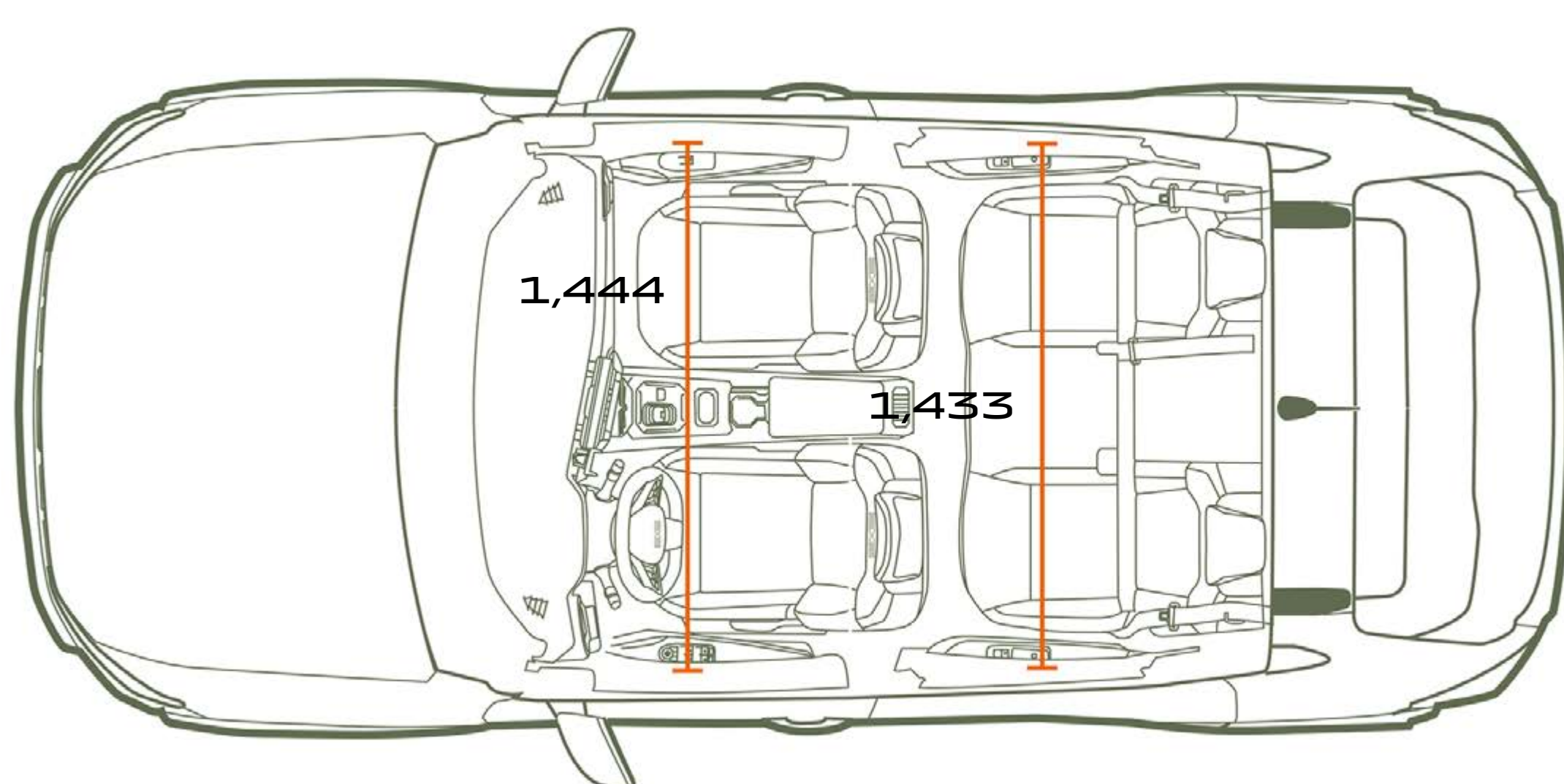

TOP VIEW

* Version 4x2
** Version 4x4

CONFIGURE AND ORDER

DACIA



Every precaution has been taken to ensure that the contents of this brochure were accurate and up to date at the time of its release. This document was created using pre-production models and prototypes. In line with its policy of continuous product improvement, Dacia reserves the right to modify the specifications, vehicles and accessories described and featured at any time. Any such modifications are communicated to Dacia dealers as quickly as possible. Depending on the country of sale, versions may differ and some equipment may be unavailable (standard, optional or accessories). Please consult your Dacia brand representative for the latest information. Because of the limitations associated with the medium, the colours featured in this document may differ slightly from those of the actual paintwork or interior trim. All rights reserved. Reproduction in any format and by any means of all or part of this brochure is prohibited without prior written authorisation from Dacia.

Dacia recommends  Castrol

PUBLICIS – PHOTO CREDITS: S. STAUB, P. CURTET, ©RENAULT MARKETING 3D-COMMERCE – APRIL 2026



[CONFIGURE
AND ORDER](#)

[BOOK A TEST
DRIVE](#)

[FIND YOUR
NEAREST CENTRE](#)