

DACIA STEPWAY



JUST ESSENTIALS

Dacia Sandero Stepway reaffirms its crossover style: take escapism to the next level thanks to the new EXTREME finish, which gives the vehicle an even stronger off-road look.



**UP TO 1108 dm³
OF BOOT
VOLUME**

**MODULAR
ROOF BARS⁽¹⁾**

**8" TOUCHSCREEN
WITH MEDIA NAV**

**EXTENDED GRIP
FUNCTION⁽²⁾**

(1) Available on Expression + Extreme version.

(2) Available only with Extreme.

INTERACTIVE MENU



01. DESIGN

02. DRIVING PLEASURE

03. INTERIOR SPACE

**04. DRIVER ASSISTANCE
SYSTEMS**

**05. EQUIPMENT AND
ACCESSORIES**

A SENSE OF ADVENTURE

A single glance and you are already itching to escape with Dacia Sandero Stepway. Its sculpted bonnet, bold front end, protective features and high ground clearance give it the dynamic and robust style of an authentic crossover. Its LED headlights, Y-shaped brand light and glossy black grille give it even more character.



Live the adventure thanks to its EXTREME finish with an even more prominent outdoor spirit: Copper Brown door mirrors, alloy wheel rims and Glossy Black shark fin antenna. A unique style topped with distinctive elements featuring topographical patterns to better identify it. And with Extended Grip, get increased traction on difficult roads (fresh snow, sand, mud).



Brand light



Extended Grip button

[CONFIGURE AND ORDER](#)

WELL-DESIGNED COMFORT

All the technologies you need: the hands-free card makes it effortless to climb in, and discover the style of the new passenger compartment. In the EXTREME finish, the interior features new, easy to clean, mixed MicroCloud plastic-coated fabric upholstery, with a soft-touch velvet appearance also present on the instrument panel and armrests. The Copper Brown touches and topographic lines recalled on the rubber floor mats complement the vehicle's unmistakable outdoor spirit.



In terms of equipment, enjoy the height- and depth-adjustable seats and steering wheel, the electric parking brake and a closed storage space in the armrest: practicality and comfort combined. Connect your smartphone and use your preferred applications on the 8-inch touch screen. The controls, all placed within easy reach, provide maximum ease of access to all functions.



Special upholstery



8-inch touch screen with Media Nav



Electric parking brake

[CONFIGURE AND ORDER](#)

03. INTERIOR SPACE

THE SPACE YOU NEED TO FIT ALL YOUR WISHES

Fold down the seats with a single touch, adjust the loading capacity as required and live life to the full.



Thanks to an ingenious system, effortlessly convert your roof bars into transverse roof bars to fit a roof compartment, a bicycle rack or a ski rack. Ready to take on the world? Let's go!



Black modular roof bars

* Expression and Extreme

[CONFIGURE AND ORDER](#)

SAFE EVERY STEP OF THE WAY

For Dacia, nothing is more important than constantly improving the safety of our vehicles, and most of all, that of the passengers. What with automatic emergency braking, hill start assist, six airbags (standard) and blind spot sensor, you can relax. Dacia Sandero and Sandero Stepway provide everything you need for worry-free driving.

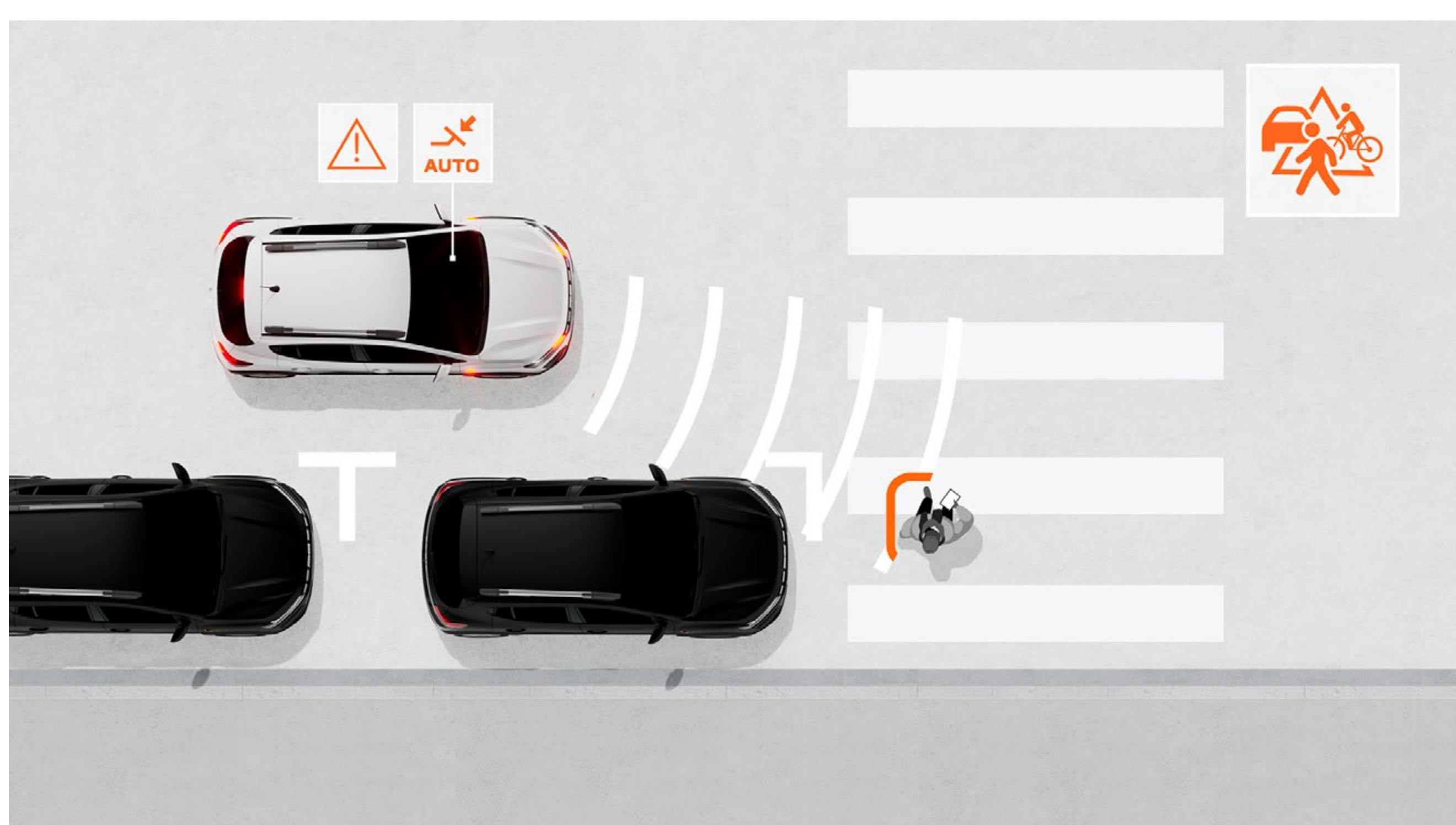

AUTOMATIC EMERGENCY BRAKING (AEBS) WITH PEDESTRIAN/CYCLIST DETECTION

This system prevents the risk of head-on collisions involving other vehicles, pedestrians or cyclists in a straight line or at junctions. It alerts the driver and can automatically brake the vehicle if necessary.

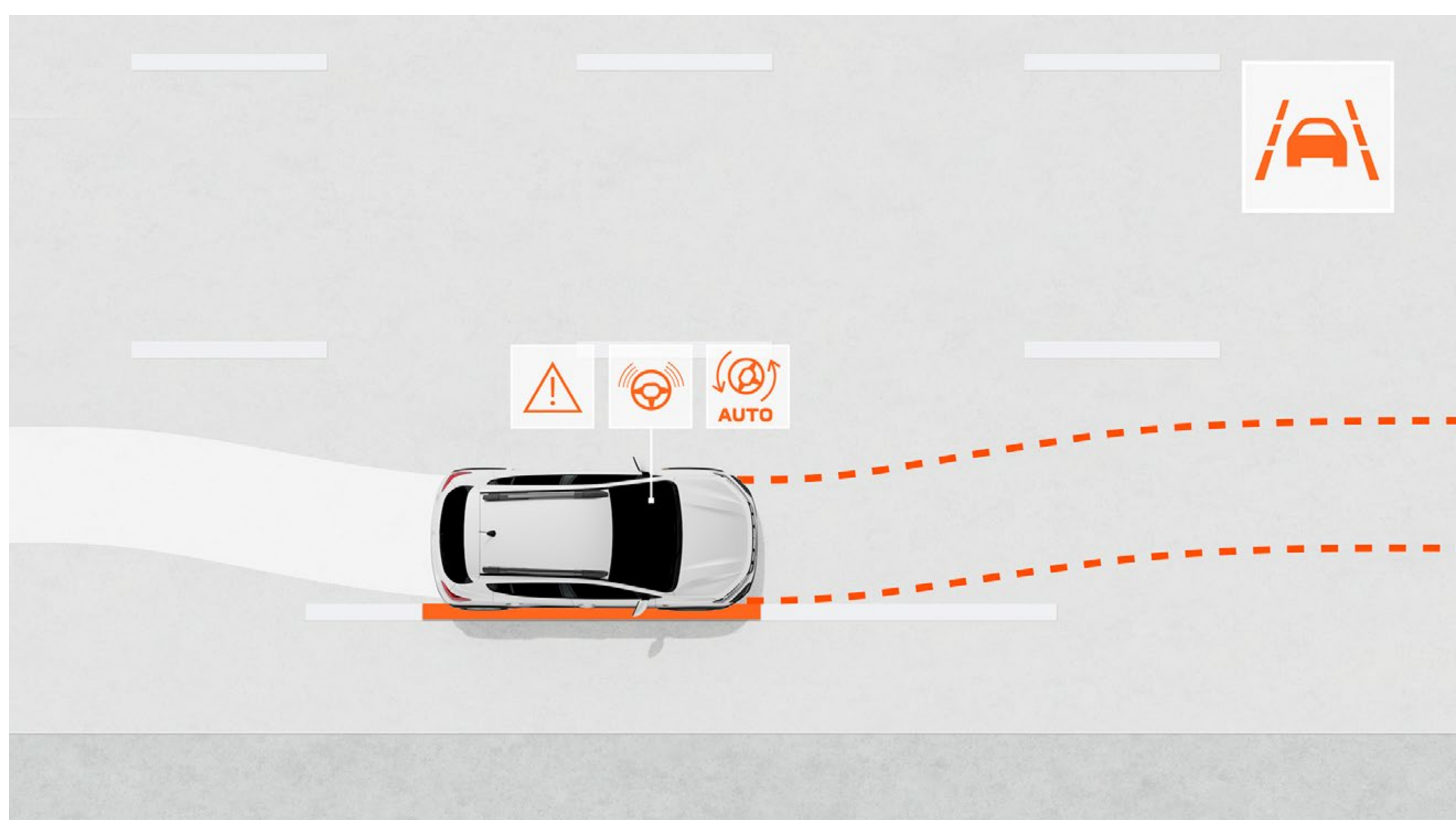

LANE KEEPING ASSIST

Monitors the vehicle's path in its lane and corrects it if necessary by automatically adjusting the steering.



DRIVER ATTENTION ALERT

Warns the driver if fatigue is detected by analysing several parameters, including steering wheel movements, to encourage him or her to take a break.

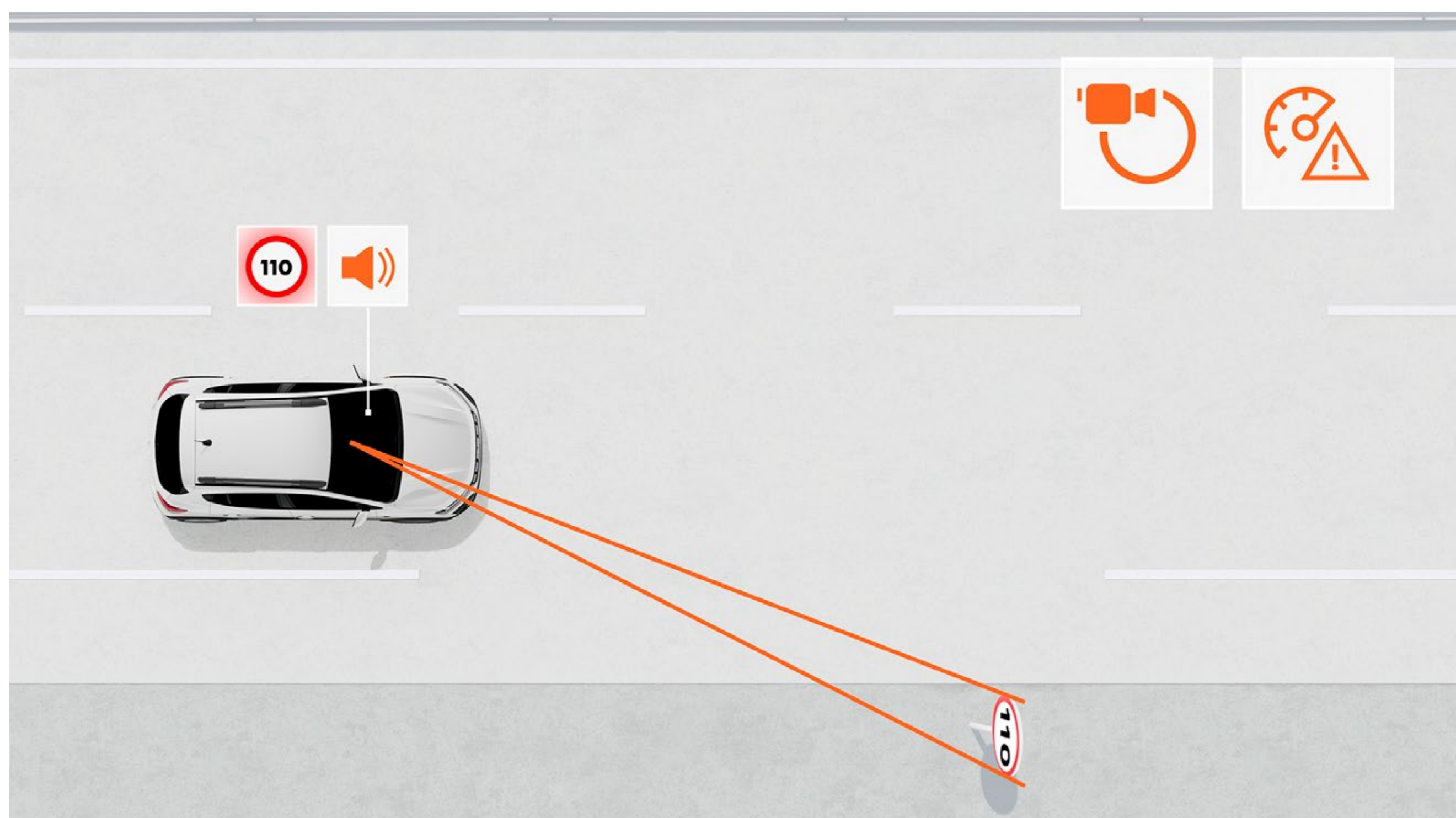

TRAFFIC SIGN RECOGNITION WITH SPEED ALERT

Provides a highly reliable, real-time indication of the maximum speed on the road ahead and warns the driver if the speed limit is exceeded with visual and audible alerts (which can be switched off).

[CONFIGURE AND ORDER](#)

**FIND OUT MORE
ABOUT OUR
EQUIPMENT** 

BODY-COLOUR PALETTE

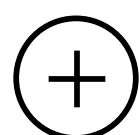

WHEEL TRIMS AND WHEELS

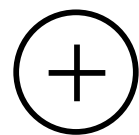

TRIMS

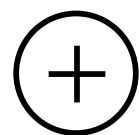

ACCESSORIES

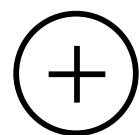

ENGINES

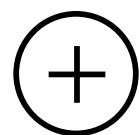

EQUIPMENT AND OPTIONS

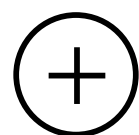

DIMENSIONS

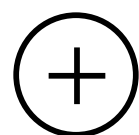

05. BODY-COLOUR PALETTE

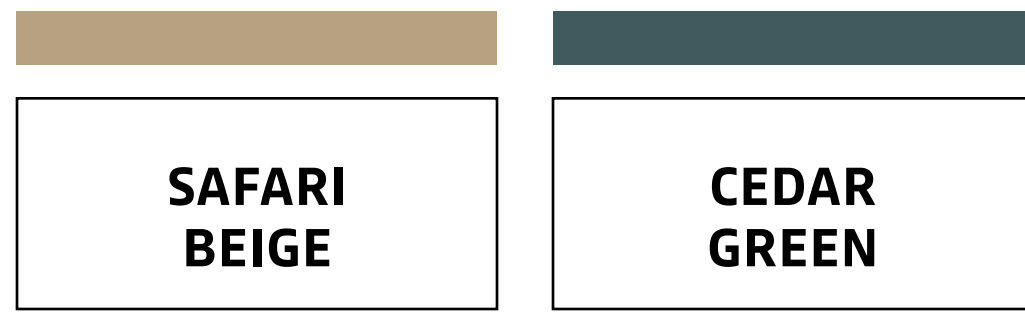

DUSTY KHAKI^{(1)*}



GLACIER WHITE⁽¹⁾



PEARL BLACK⁽²⁾



SHADOW GREY⁽²⁾



IRON BLUE^{(2)*}



SAFARI BEIGE^{(2)*}



CEDAR GREEN^{(2)*}

(1) Opaque paint. (2) Metallic paint.

*Not available on ESSENTIAL.

Non-binding photos.

ESSENTIAL EXPRESSION EXTREME

| COLOUR AVAILABILITY | | | |
|---|---|---|---|
| SOLID PAINT | | | |
| 369 Glacier White | ○ | ○ | ○ |
| METALLIC PAINT | | | |
| 676 Pearl Black | ○ | ○ | ○ |
| KQG Shadow Grey | ○ | ○ | ○ |
| DQK Cedar Green | - | ○ | ○ |
| RQH Iron Blue | - | ○ | ○ |
| HNY Safari Beige | - | ○ | ○ |
| SPECIAL PAINT (PRICED AS METALLIC) | | | |
| KQM Dusty Khaki | - | ○ | ○ |

○ = Optional. - = Not available.

05. WHEEL TRIMS AND WHEELS



ATARA 16" FLEXWHEEL



16" MAHALIA BLACK ALLOY WHEEL⁽²⁾

(1) Essential and Expression version.

(2) Only available in the EXTREME version.

05. TRIMS

ESSENTIAL



MAIN EQUIPMENT

EXTERNAL APPEARANCE

- Black grille with Dacia logo and white Stepway inscription
- LED signature light
- Automatic activation of daytime LED running lights
- 16" Atara Flexwheels
- Body coloured front/rear bumpers
- Megalith Grey front/rear skid plates
- Black exterior door handles
- Black door mirrors
- Modular longitudinal roof bars (black fixed bars)

INTERIOR DESIGN

- Black air vent surrounds
- Black interior door handles
- 1/3- 2/3 split-fold rear bench seatback
- Specific stepway upholstery with contrast stitching

ACTIVE AND PASSIVE SAFETY

- My Safety button to manage driving aids
- Anti-lock Braking System (ABS) and Emergency Brake Assist (EBA)
- Automatic emergency braking (AEBS) with pedestrian/cyclist detection
- Electronic Stability Control (ESC) with Hill Start Assist (HSA)
- Emergency call (E-call)
- Event (accident) data recorder
- Prewiring for ethylometric immobiliser
- Traffic sign recognition with speed alert
- Lane change warning
- Lane keeping assist
- Driver attention alert
- Front/rear "Rescue Code"® QR Code
- Driver's front airbag/passenger's front airbag can be deactivated
- Shoulder and curtain side airbags
- Rear parking sensors
- Tyre pressure detection
- Tyre inflation kit
- Isofix child seat mounting system on rear side seats

DRIVING AND CONTROL INSTRUMENTS

- Electrical power-assisted steering
- Stop & Start, ECO Mode
- On-board computer: distance travelled, average speed, range, average consumption (including for LPG)
- Rain and light sensors
- Cruise control and speed limiter with audible warning

VISIBILITY

- Door mirrors with interior manual adjustment

COMFORT

- Manual heating and air conditioning system
- Electric door locking with radio frequency remote
- Automatic locking of doors when in motion
- Front electric driver and passenger windows
- Height-adjustable steering wheel
- Front ceiling light
- 1 x 12V socket in the front

MULTIMEDIA AND AUDIO

- New Media Control: DAB radio with steering wheel controls, 1 jack and 2 speakers, Bluetooth® telephone with side controls on the steering wheel, fixed smartphone holder on the dashboard, new Dacia Media Control smartphone application.
- 1 USB socket in the front

OPTION

- Spare wheel + jack (Not available on Bi-Fuel version)
- Paint colours available in Glacier White (solid), Pearl Black (metallic), and Shadow Grey (metallic)

EXPRESSION



MAIN EQUIPMENT EXPRESSION = ESSENTIAL +

EXTERNAL APPEARANCE

- Body coloured exterior door handles
- Body coloured door mirrors
- Specific decal on front doors
- Side protection stickers
- Modular roof bars (black)

INTERIOR DESIGN

- Fog Grey air vent surrounds
- Steel Grey interior door handles
- Fabric upholstery on the dashboard and front door armrests
- Soft feel adjustable steering wheel

VISIBILITY

- Front fog lights
- Electrically operated door mirrors

COMFORT

- 4 electric windows, with driver's side one-touch control
- Keyless entry
- Automatic windscreen wipers

ACTIVE AND PASSIVE SAFETY

- Rear-parking sensor and reversing camera

MULTIMEDIA AND AUDIO

- Media Display: multimedia system with 8" touchscreen, DAB digital radio, smartphone mirroring via USB cable, Bluetooth® connection, side controls on steering wheel, 4 speakers and 1 USB-A socket

OPTIONS

- Metallic or special paint
- Spare wheel (Not available on TCe 100 Bi-Fuel versions)

EXTREME



MAIN EQUIPMENT EXTREME = EXPRESSION+

EXTERNAL APPEARANCE

- Specific outdoor design with door bottom protectors and side stickers with topographical motifs
- Copper Brown finish: door mirrors, "Stepway" inscription on roof bars, decorative fog moulding
- 16" Mahalia black alloy wheels
- Shark fin aerial
- Modular roof bars (Black)

INTERIOR DESIGN

- EXTREME specific upholstery with washable TEP MicroCloud fabric, with Copper stitching and embossed Dacia logo
- Copper decoration: decorative strips on the door panels
- Washable TEP MicroCloud fabric coating on the dashboard and on the front door armrests
- Front + rear rubber floor mats with topographic patterns

ACTIVE AND PASSIVE SAFETY

- Blind spot warning
- Front and rear parking sensors with reversing camera

DRIVING AND CONTROL INSTRUMENTS

- Extended Grip function

COMFORT

- Automatic heating and air conditioning system
- Modular boot with twin-level floor
- Electric parking brake and high central armrest with storage
- Rear USB-C socket
- Heated front seats

MULTIMEDIA AND AUDIO

- Removable phone holder
- Media Nav with inbuilt navigation, Android Auto™ and Apple CarPlay™ compatibility with smartphone replication, Bluetooth® connection, DAB radio with 8" touchscreen and 6 speakers and 1 USB-A socket

OPTIONS

- Metallic paint
- Spare wheel (Not available on TCe 100 Bi-Fuel versions)

05. ACCESSORIES

STYLE PACK (ESSENTIAL & EXPRESSION)



Roof spoiler



Shark fin aerial



Illuminated door sills

PROTECTION PACK (ESSENTIAL)



Front & rear lower door protectors



Front & rear mud guards



Boot mat

Available for Expression & Extreme versions:
Mud guards & boot mat

STORAGE PACK

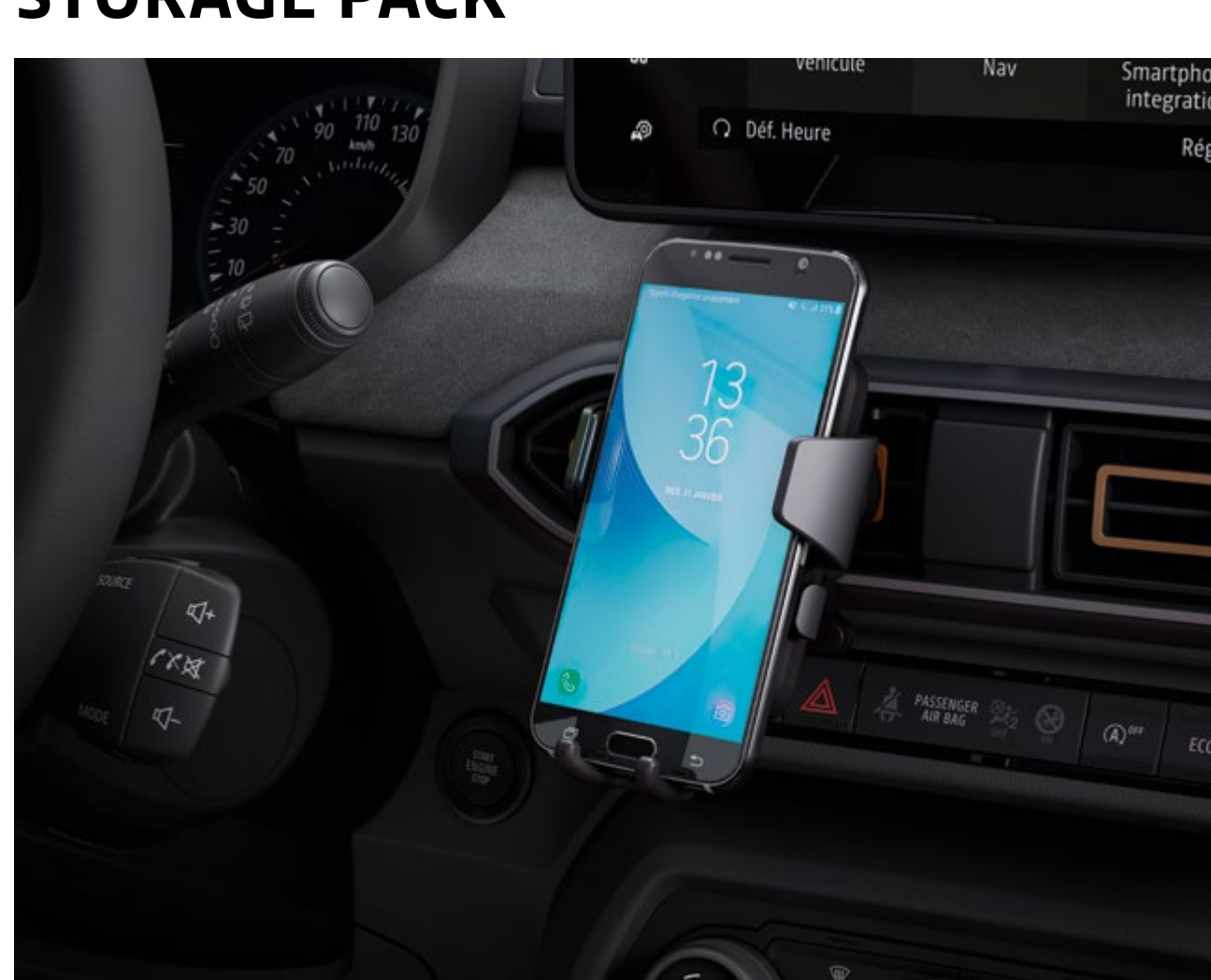

Magnetic phone holder



Rear tray table & fixings

Storage pack + available with 2 x rear tray tables & fixings

TOURING PACK



Roof bars



Roof box 400L

DASH CAM PACK



Front and rear dashcam

CYCLE PACK



Roof bars



2 x bike carriers for roof

TOW BARS



Swan neck towbar 13 pin
Removable towbar 13 pin

PREMIUM DELIVERY PACKS

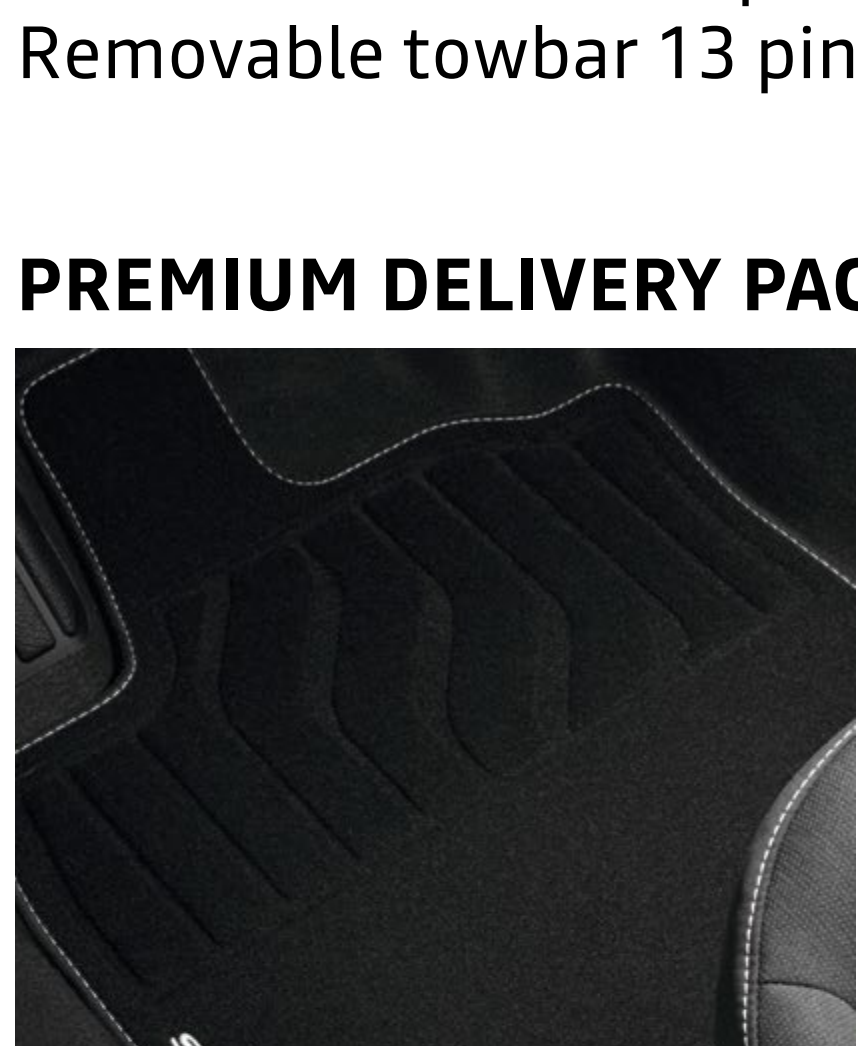

Premium mats



Safety kit



Key card wallet

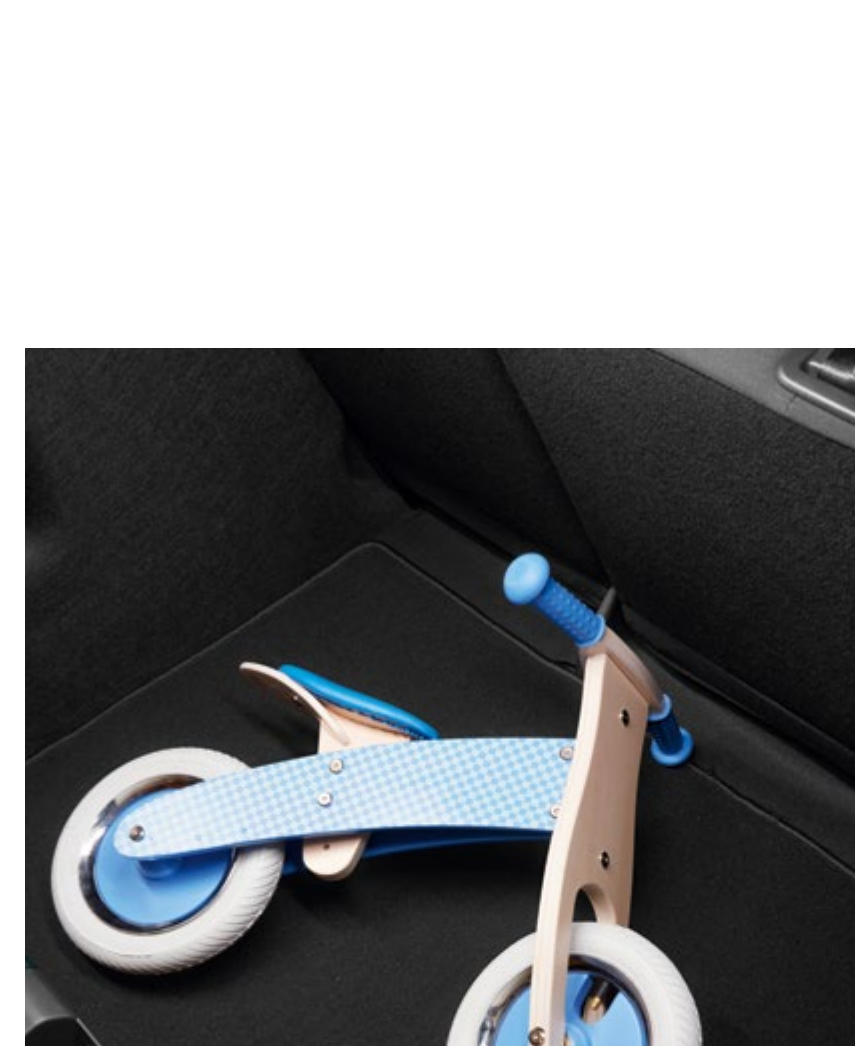

Textile boot mat

PREMIUM DELIVERY PACK

Premium mats
Safety kit
Key card wallet

PREMIUM DELIVERY PACK+

Premium mats
Safety kit
Key card wallet
Textile boot mat

SPARE WHEEL KIT

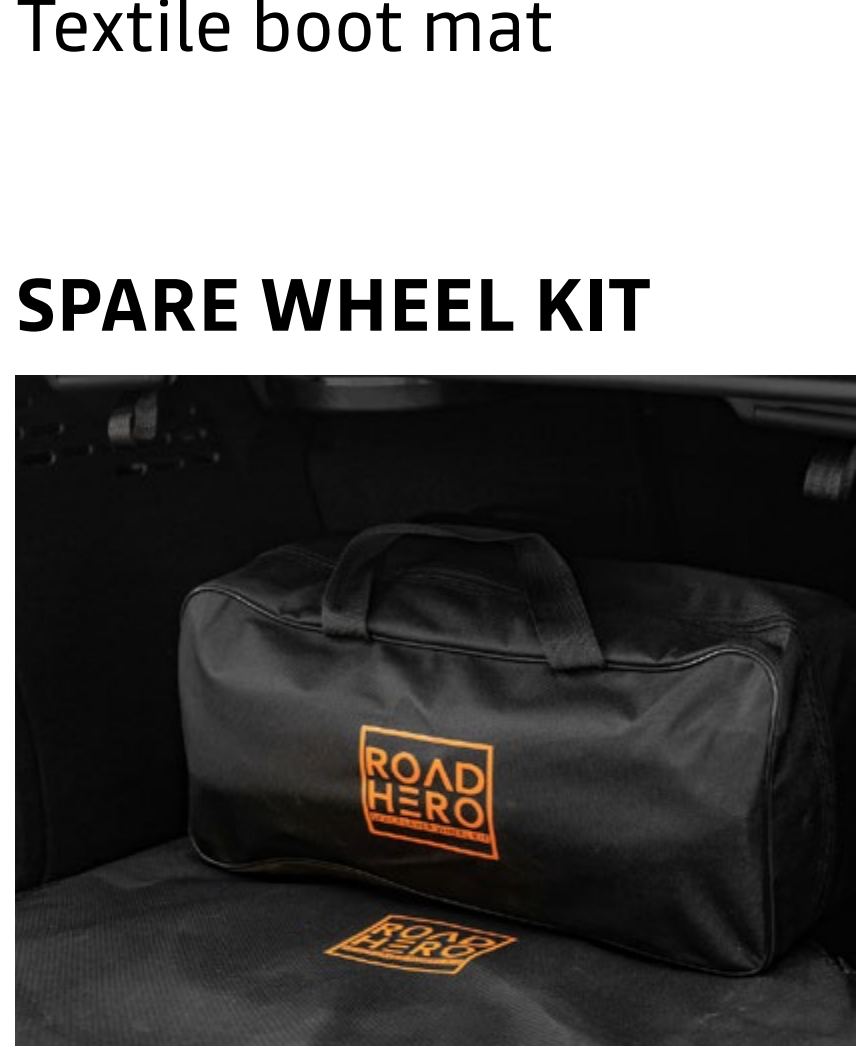

All accessories purchased prior to vehicle registration come with a 3 year manufacturers warranty
Accessories are fitted post production and may have an impact on WLTP fuel (actual) consumption and CO₂ figures

[DOWNLOAD THE ACCESSORIES BROCHURE](#)

05. ENGINES

| | TCe 90 | TCe 90 CVT | Bi-Fuel 100 | TCE 110 |
|---|--------------------------|---------------------|---|---------------------|
| ENGINES | | | | |
| Fiscal rating (CV) (France) | 5 | 5 | 5 | 5 |
| Fuel | Unleaded fuel (E10) | Unleaded fuel (E10) | Unleaded fuel (E10)/ LPG | Unleaded fuel (E10) |
| Max. power kW CEE (hp) at an engine speed of (rpm) | 67 at 4,600-5,000 | 67 at 4,500-5,000 | LPG mode: 74 at 4,600-5,000 Petrol Mode: 67 at 4,800-5,000 | 81 at 5,000-5,250 |
| Max. torque Nm CEE (m.kg) at an engine speed of (rpm) | 160 at 2,200-3,750 | 142 at 1,750-3,750 | LPG mode: 170 at 2,000-3,500 Petrol Mode: 160 at 2,100-3,750 | 200 at 2,900-3,500 |
| Gearbox type | Manual 6-speed | Auto-CVT | Manual 6-speed | Manual 6-speed |
| Type of Injection | Turbo indirect injection | | | |
| Capacity (cm ³) | 999 | | | |
| Number of cylinders/valves | 3/12 | | | |
| Emission control standard | Euro 6 DFull | | | |

CHASSIS AND STEERING

| | | | | |
|---|--|--|--|--|
| Tyre dimensions | 205/60 R16 92H | | | |
| Steering - Turning circle, kerb to kerb (m) | 10.39 | | | |
| Front suspension | Pseudo McPherson with lower wishbone, spiral spring suspension with telescopic hydraulic shock absorbers and anti-roll bar | | | |
| Rear suspension | Semi-rigid axle with anti-roll bar spring suspension and telescopic hydraulic shock absorbers | | | |

PERFORMANCE

| | | | LPG | Petrol | |
|---|--------------------|------|------|--------|------|
| Maximum speed (mph) | 107 | 101 | 108 | 110 | 112 |
| 0-62 mph (s) | 12 | 14.2 | 11.9 | | 10 |
| Mid-range acceleration: 50 mph- 75 mph (s) | in 4 th | | | | |
| | 5 th | 10.3 | 10.0 | 10.2 | 7.7 |
| | 6 th | 14.6 | 13.9 | 14.4 | 10.7 |
| | | 22.6 | 20.6 | 21.9 | 17.1 |

FUEL CONSUMPTION AND EMISSIONS⁽¹⁾

| Approval protocol | WLTP ⁽²⁾ | | | | |
|---|---------------------|------|-----------------------|-----------|------|
| Fuel tank capacity (l) | 50 | 50 | Petrol: 50 LPG: 40 | | 50 |
| | | | LPG | Petrol | |
| CO ₂ emissions (g/km) Best Case - Worst Case | 125/127 | 140 | 113/114 | 130/131 | 125 |
| Fuel consumption during combined cycle (mpg) Best Case - Worst Case | 50.4/51.4 | 45.6 | 39.8/40.4 | 48.7/49.6 | 51.5 |

VOLUMES AND WEIGHTS

| | Essential | Expression/ Extreme | Essential | Expression/ Extreme | Essential | Expression/ Extreme | Essential | Expression/ Extreme |
|---|-----------|------------------------|-----------|------------------------|-----------|------------------------|-----------|------------------------|
| Minimum kerb weight | 1,077 | 1,096 | 1,113 | 1,122 | 1,134 | 1,154 | 1,098 | 1,106 |
| Maximum kerb weight | 1,119 | 1,136 | 1,143 | 1,159 | 1,160 | 1,176 | 1,130 | 1,145 |
| Gross train weight (GTW) | 2,661 | 2,678 | 2,685 | 2,701 | 2,702 | 2,718 | 2,672 | 2,687 |
| Maximum permissible laden weight (MPLW) | 1,561 | 1,578 | 1,585 | 1,601 | 1,602 | 1,618 | 1,572 | 1,587 |
| Max. braked towing weight | 1,100 | 1,100 | 1,100 | 1,100 | 1,100 | 1,100 | 1,100 | 1,100 |

(1) Official consumption and emissions according to applicable regulations. (2) WLTP (Worldwide Harmonised Light Vehicle Test Procedures): this new protocol provides results much closer to those found in daily use compared with the NEDC protocol. Fuel consumption and CO₂ emissions are certified using a standard, regulated method. This method is identical for all manufacturers and enables vehicles to be compared.

CONFIGURE AND ORDER

05. EQUIPMENT AND OPTIONS

| | ESSENTIAL | EXPRESSION | EXTREME |
|--|--------------------------|--------------------------|--------------------------|
| EXTERNAL APPEARANCE | | | |
| LED brand light | • | • | • |
| LED automatic daytime running lights | • | • | • |
| Grille | Black | Black | Black |
| Grille Logo «Stepway» inscription | White | White | White |
| Dacia rear lettering | White | White | Copper |
| Front/rear bumpers | Body-coloured | Body-coloured | Body-coloured |
| Megalith Grey front/rear skid plates | • | • | • |
| Side protection stickers/snorkel-type sticker | - | •/- | Topographic pattern |
| Exterior door handles | Black | Body-coloured | Body-coloured |
| Door mirrors | Black | Body-coloured | Copper |
| Longitudinal roof bars (black) | • | - | - |
| Modular roof bars (black) | - | • | • |
| 16" Atara Flexwheels | • | • | - |
| 16" Mahalia black alloy wheels | - | - | • |
| Shark fin antenna | - | - | • |
| White expression decal on front doors | - | • | - |
| INTERIOR APPEARANCE | | | |
| Centre of air vents | Copper and white sliders | Copper and white sliders | Copper and white sliders |
| Air vent surrounds | Black | Fog Grey | Fog Grey |
| Interior door handles | Black | Steel Grey | Steel Grey |
| Upholstery on the dashboard and front door armrests/trim on the front door panels | -/- | Fabric / Fabric | MicroCloud Fabric |
| 1/3- 2/3 split-fold rear bench seatback | • | • | • |
| Soft feel steering wheel | - | • | • |
| Essential & Expression upholstery | • | • | - |
| Extreme MicroCloud plastic-coated fabric upholstery | - | - | • |
| ACTIVE AND PASSIVE SAFETY | | | |
| My Safety button to manage driver-assistance systems | • | • | • |
| Anti-lock Braking System (ABS) and Emergency Brake Assist (EBA) | • | • | • |
| Automatic emergency braking (AEBS) with pedestrian/cyclist detection | • | • | • |
| Electronic Stability Control (ESC) with Hill Start Assist (HSA) | • | • | • |
| Emergency call (E-call) | • | • | • |
| Event (accident) data recorder | • | • | • |
| Alcohol Immobiliser predisposition | • | • | • |
| Traffic sign recognition with speed alert / Intelligent Speed Assist (ISA) | • | • | • |
| Lane Departure Warning(LDW) + Lane Keep Assist (LKA) | • | • | • |
| Driver attention alert | • | • | • |
| Front / rear "Rescue Code®" QR Code | • | • | • |
| Driver's front airbag/passenger's front airbag can be deactivated | •/• | •/• | •/• |
| Shoulder and curtain side airbags | • | • | • |
| Rear parking sensors | • | • | • |
| Rear view camera | - | • | • |
| Front parking sensors | - | - | • |
| Blind spot warning | - | - | • |
| Electric parking brake with high central armrest with storage compartment, 1 12V socket and 1 USB-C socket in the rear | - | - | • |
| Tyre pressure monitor | • | • | • |
| Spare wheel + jack (except TCe 100 Bi-Fuel) | o | o | o |
| Tyre inflation kit | • | • | • |
| Isofix child seat mounting system on rear side seats | • | • | • |
| 180kmh/112mph speed limiter | • | • | • |

-: not available; •: available as standard; o: available as an option.

DRIVING AND CONTROL INSTRUMENTS

| | | | |
|--|---|---|---|
| Electrical power-assisted steering | • | • | • |
| Stop & Start | • | • | • |
| On-board computer: distance travelled, average speed, range, average consumption (including for LPG) | • | • | • |
| Rain and light sensors | • | • | • |
| Cruise control/Speed limiter with audible warning | • | • | • |
| Extended Grip | - | - | • |

VISIBILITY

| | | | |
|--|---|---|---|
| Front fog lights | - | • | • |
| Door mirrors manually adjustable from inside | • | - | - |
| Electrically adjustable door mirrors | - | • | • |

COMFORT

| | | | |
|--|-----|-----|-----|
| Manual heating and air conditioning system | • | • | - |
| Automatic heating and air conditioning system | - | - | • |
| Automatic screen wipers | - | • | • |
| Electric door locking with radio frequency remote control | • | • | • |
| Automatic locking of doors when in motion | • | • | • |
| Keyless Entry | - | • | • |
| Front electric driver and passenger windows | • | • | • |
| One-touch driver-seat window control (with anti-trapping function), non one-touch passenger side | - | • | • |
| Electric rear windows | - | • | • |
| Height- and reach-adjustable steering wheel | o/- | o/• | o/• |
| Front ceiling light | • | • | • |
| 1 x 12V socket in the front | • | • | • |
| Heated front seats | - | - | • |
| Modular boot with twin-level floor | - | - | • |

MULTIMEDIA & AUDIO

| | | | |
|--|---|---|---|
| New Media Control: DAB radio with steering wheel controls, jack socket, 2 speakers, Bluetooth® telephone system with side controls on the steering wheel, fixed smartphone holder on the dashboard, new Dacia Media Control smartphone app | • | - | - |
| Media Display: multimedia system with 8" touchscreen, DAB digital radio, smartphone mirroring via USB cable, Bluetooth® connection, side controls on steering wheel, 4 speakers and 1 USB-A socket | - | • | - |
| Media Nav: multimedia system with 8" touchscreen, navigation with Map Care (map of Western Europe or Eastern Europe [depending on country] + 6 free updates for 3 years), DAB digital radio, smartphone replication via USB cable or wireless via Wi-Fi, Bluetooth® connection, side controls on steering wheel, 6 speakers (4 speakers + 2 tweeters) and 1 USB-A socket | - | - | • |
| Removable phone holder | - | - | • |

-: not available; •: available as standard; o: available as an option.

CONFIGURE AND ORDER

05. DIMENSIONS

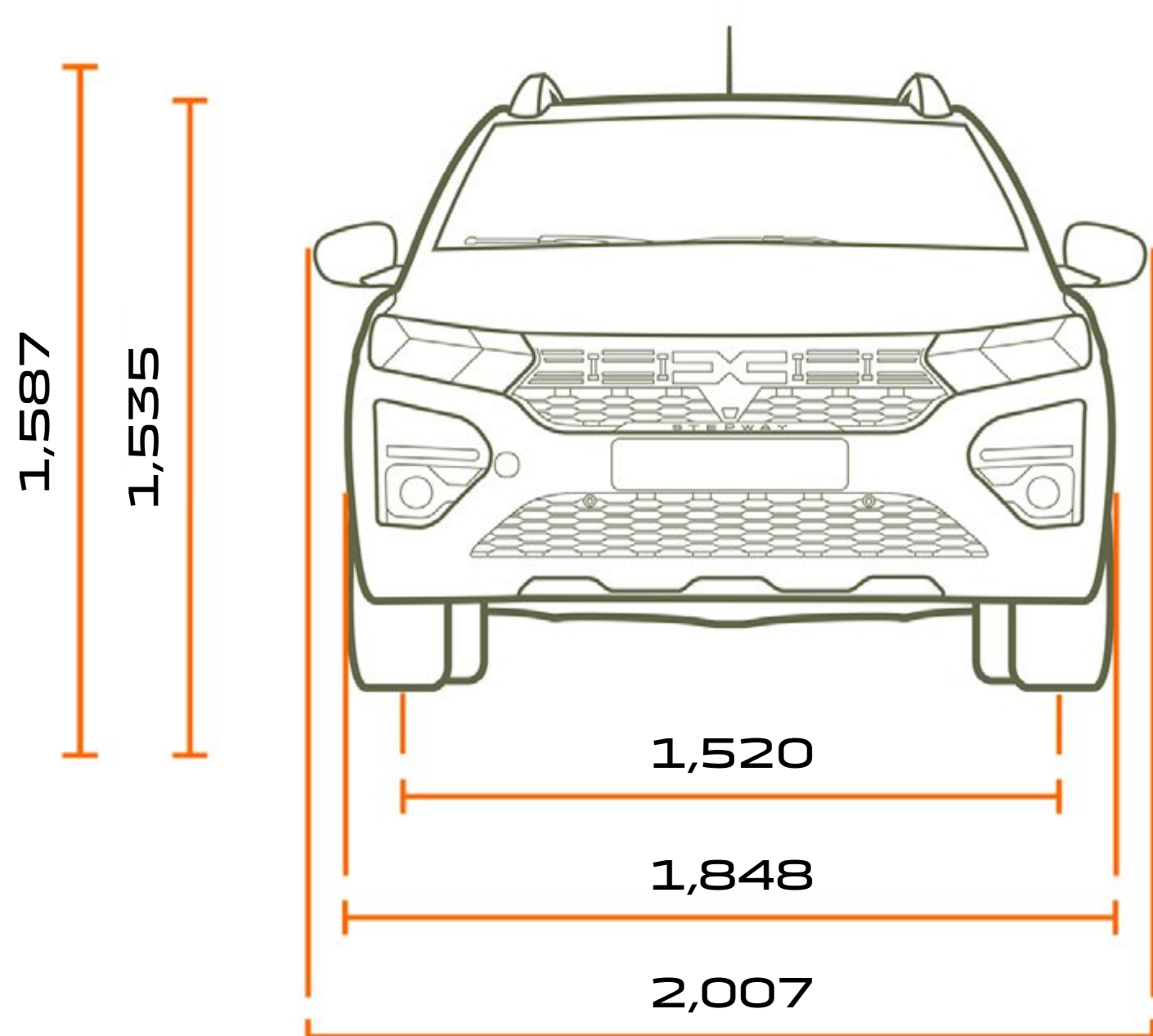

FRONT VIEW

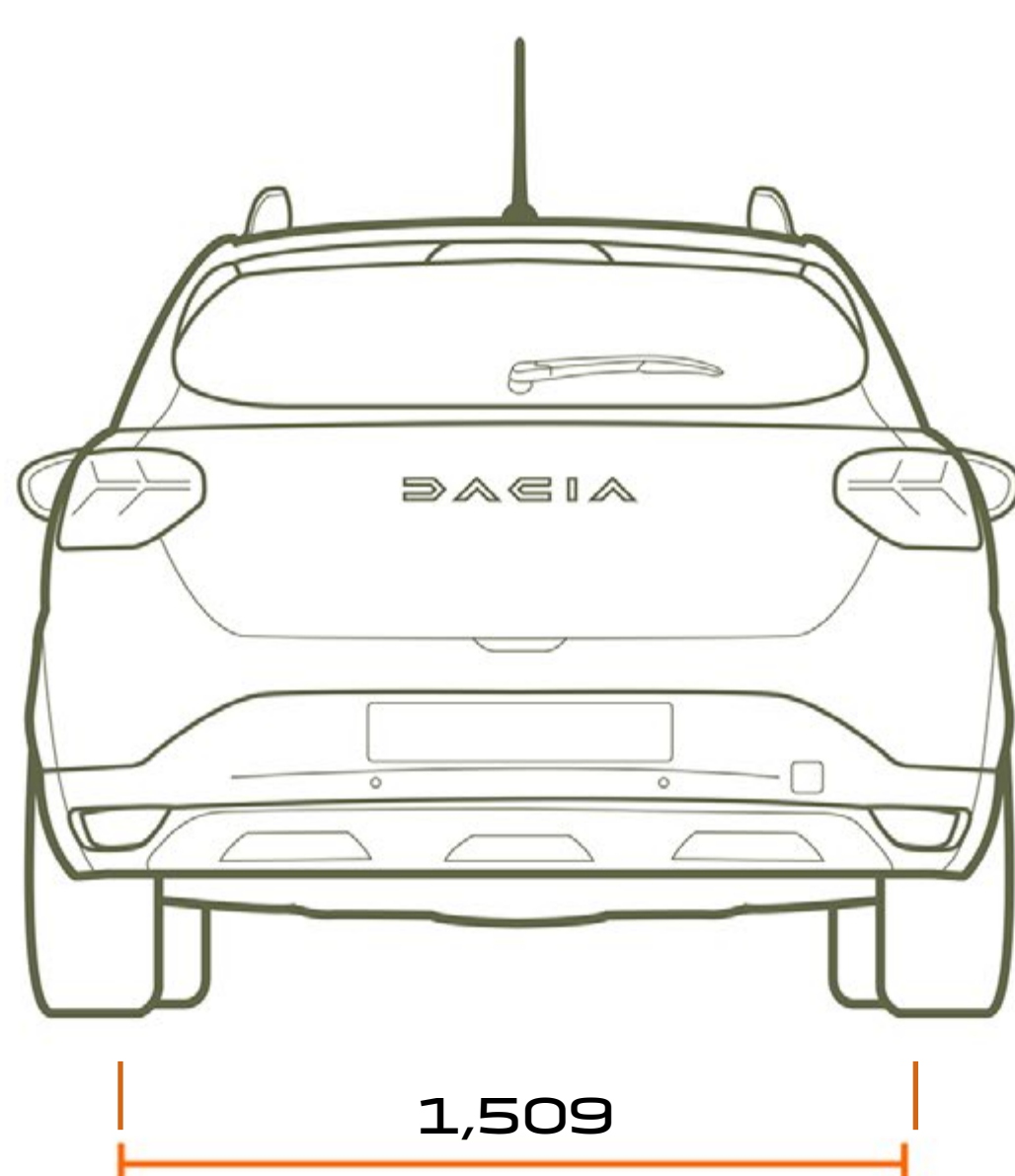

REAR VIEW

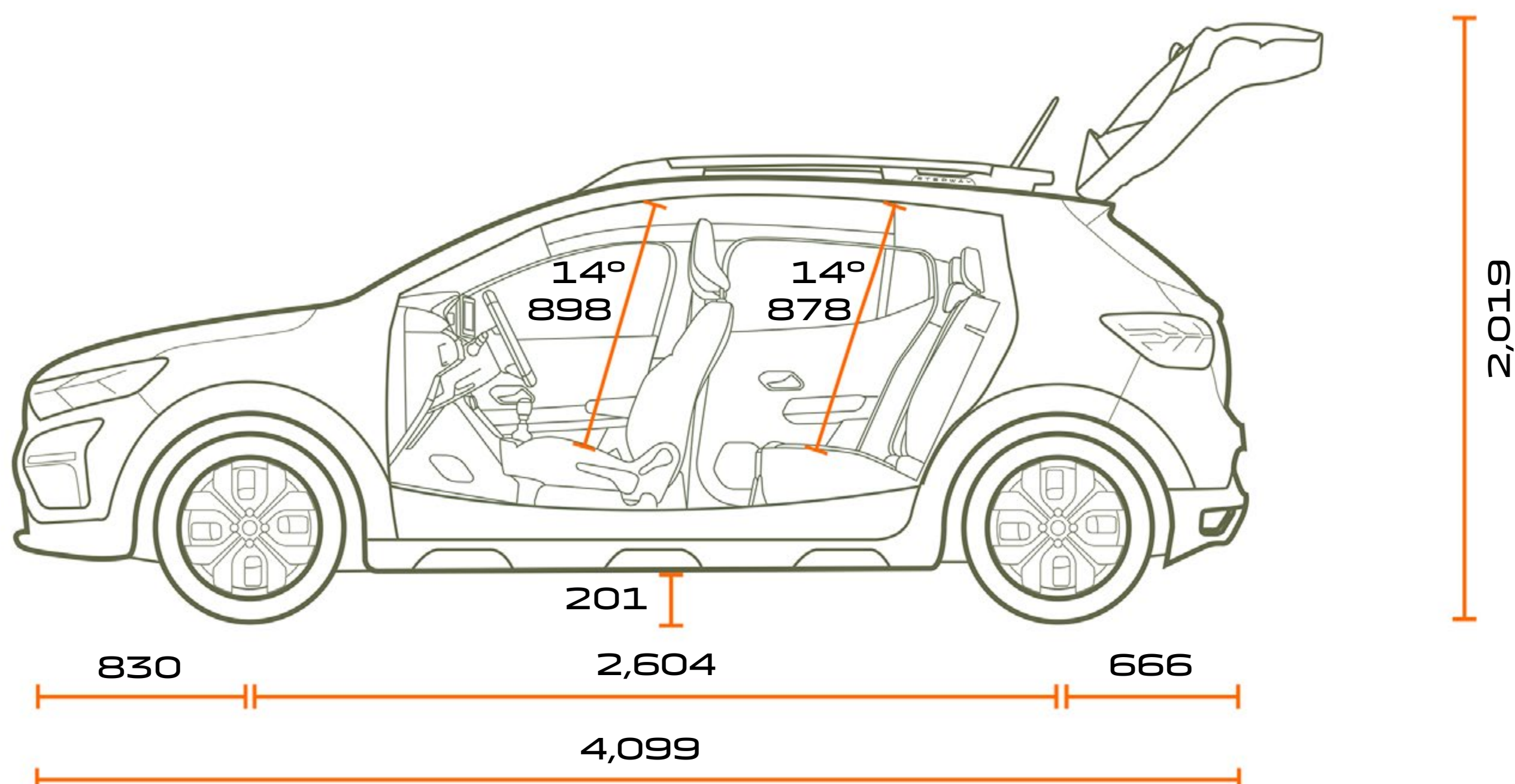

SIDE-FACE VIEW

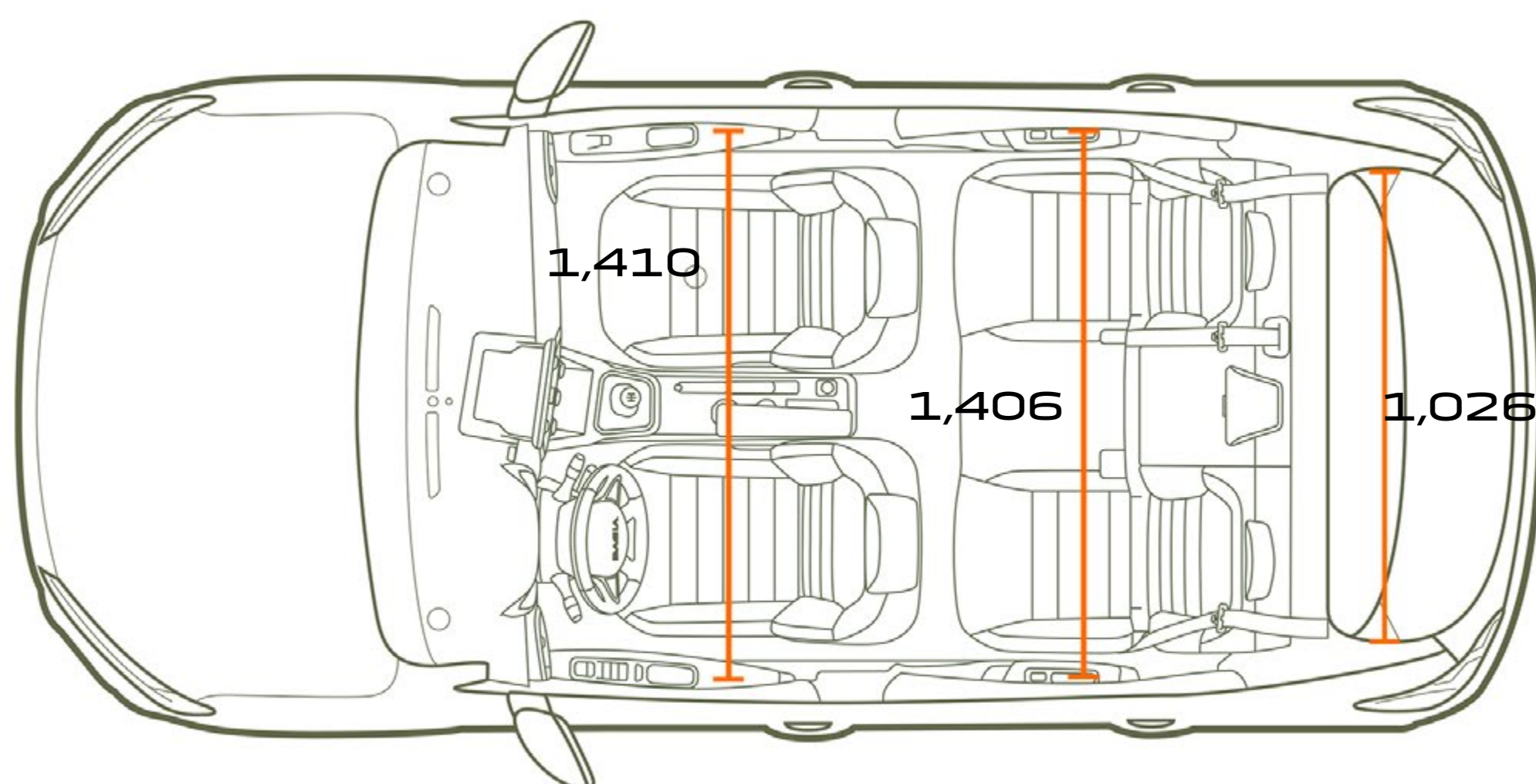

TOP VIEW

**BOOT VOLUME
(IN DM³ - VDA STANDARD / LITRES)**

| | |
|---|-------------|
| Minimum boot volume(ISO 3832 standard) | 328/410 |
| Maximum boot volume (ISO 3832 standard) | 1,108/1,455 |
| Volume under false floor (ISO 3832) | 78 |

CONFIGURE AND ORDER

DAECIA



Every precaution has been taken to ensure that the contents of this brochure were accurate and up-to-date at the time of publication. This document was created using pre-production models and prototypes. In line with its policy of continuous product improvement, Dacia reserves the right to modify the specifications, vehicles and accessories described and featured at any time. Any such modifications are communicated to Dacia dealers as quickly as possible. Depending on the country of sale, versions may differ and some equipment may be unavailable (standard, optional or accessories). Please consult your Dacia brand representative for the latest information. For reasons to do with the medium, the colours featured in this document may differ slightly from those of the actual paintwork or interior trim. All rights reserved. Reproduction in any format and by any means of all or part of this publication is prohibited without prior written authorisation from Dacia.

Dacia recommends  Castrol

PUBLICIS – PHOTO CREDITS: S. STAUB, BAM (BEN & MARTIN), ADDITIVE, MAGROUND, ©RENAULT MARKETING 3D-COMMERCE – APRIL 2025



[CONFIGURE
AND ORDER](#)

[BOOK
A TEST DRIVE](#)

[FIND YOUR
NEAREST CENTRE](#)