



RENAULT

TRAFIC VAN E-TECH Electric



Alle Typen
(2023 -)

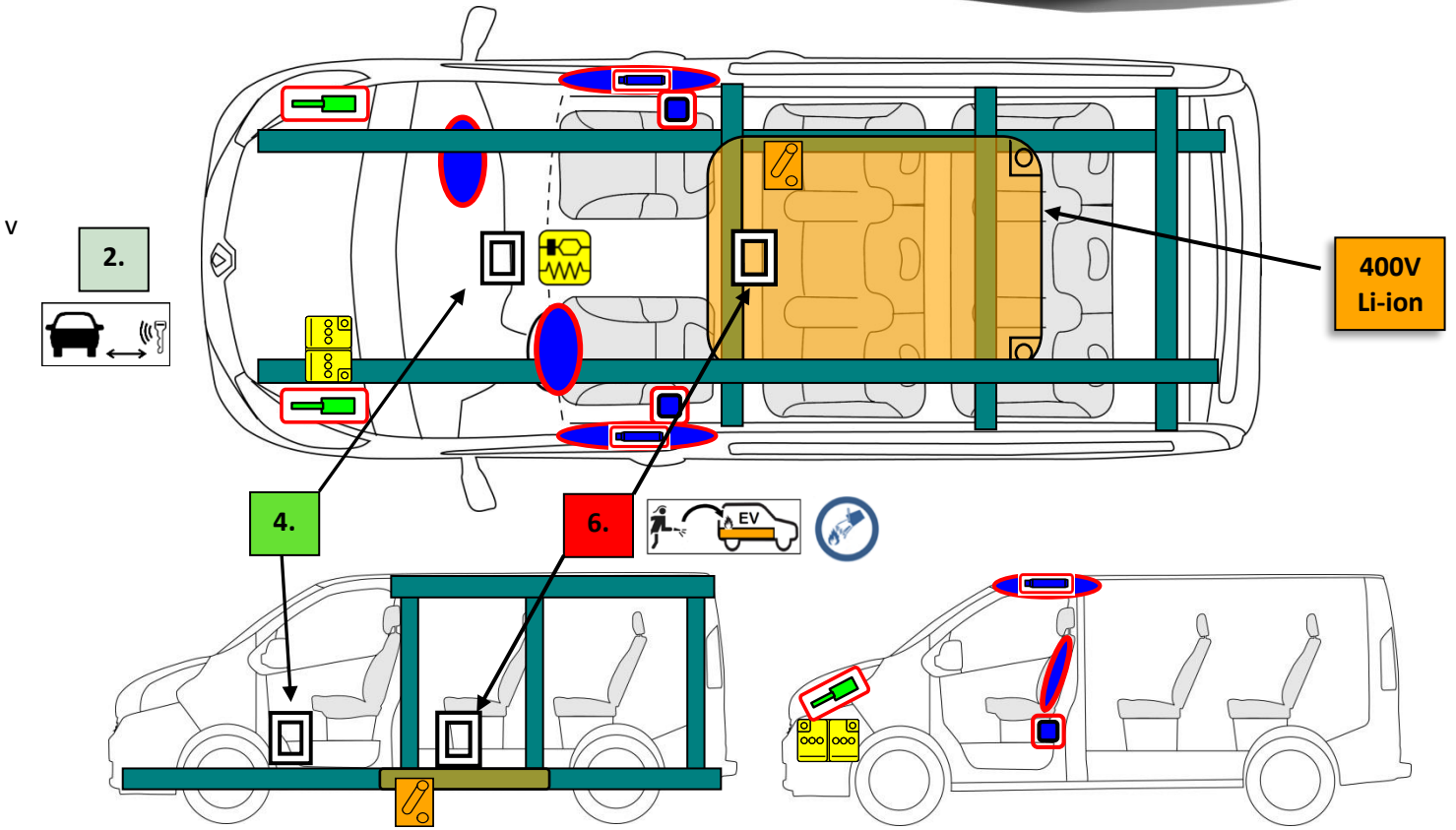

	Airbag		Gasgenerator		Gurtstraffer		SRS Steuergerät		
			Gasdruckdämpfer / vorgespannte Feder		Karosserie-Verstärkung		Bereich Bedarf besonderer Aufmerksamkeit		
	Niedervolt-Batterie								
	Hochspannungsbatterie		Hochspannungskabel		Hochvolt-Trennstelle				

In Zusammenarbeit mit



MINISTÈRE DE L'INTÉRIEUR

Interne Bezeichnung	Version	Version	Seite 1 / 4
RS-X82 EV-2023	10/07/2023	1	

1. Identifizierung/Erkennung



2. Immobilisieren/Stabilisieren/Anheben

Immobilisieren



Motorstillstand

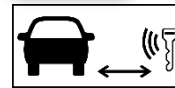

3. Direkte Gefahren ausschalten/Sicherheitsbestimmungen

12 V-Batterie

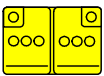

- 1- Motorstillstand
- 2 - Minuspol (-) abklemmen

Interne Bezeichnung	Version	Version	Seite
RS-X82 EV-2023	10/07/2023	1	2 / 4

400 V-Batterie



Nur im Rettungs-/Bergungsfalle! :

Abschalten der 400 V-Batterie: Service-Plug entfernen

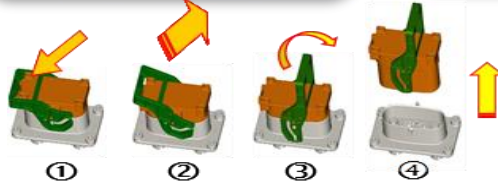
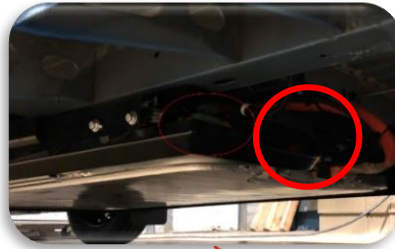
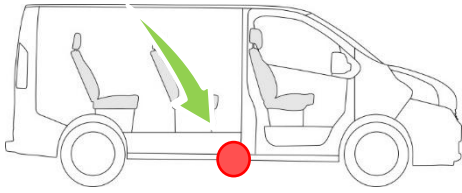

4. Zugang zu den Insassen

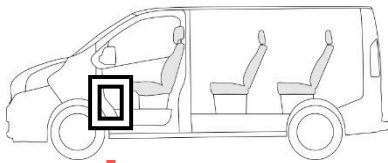

Verstärkungen beidseitig der Mitterkonsole

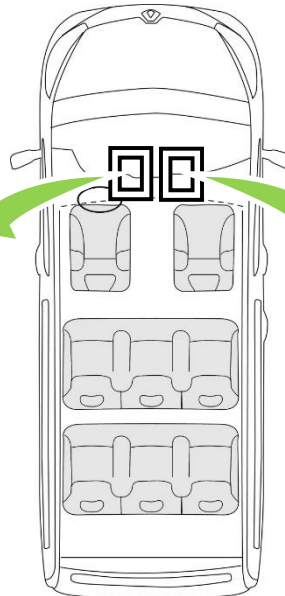

HOCHELASTISCHER STAHL

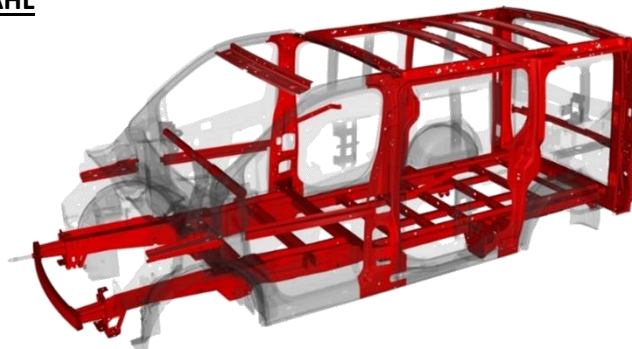
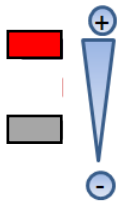

5. Gespeicherte Energie/Flüssigkeiten/Gase/Feststoffe

	Lithium-ion	52 kW.h	400 V	
--	-------------	---------	-------	--

In Zusammenarbeit mit



MINISTÈRE DE L'INTÉRIEUR

Interne Bezeichnung

Version

Version

Seite

RS-X82 EV-2023

10/07/2023

1

3 / 4

6. Im Brandfall

Auslöschten einer Traktionsbatterieleuchte



Wenn die Traktionsbatterie brennt : → Wasserlöschung durch Einfüllen

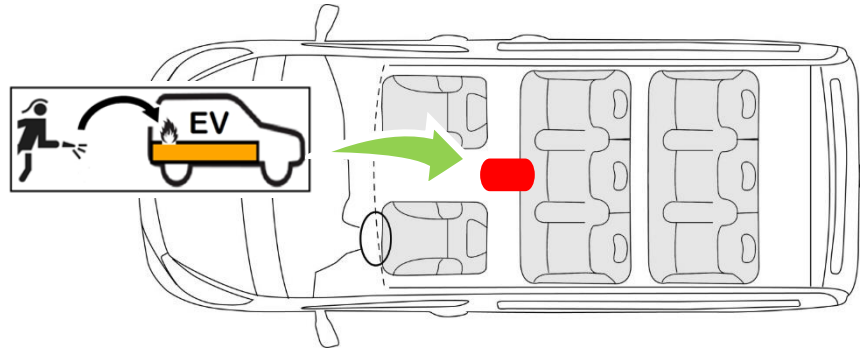

GASDRUCKDÄMPFER



Explosionsgefahr durch Gasdruckdämpfer!

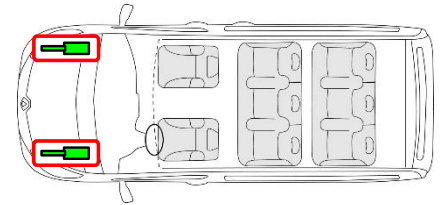

7. Im Falle des Untertauchens



Kein elektrisches Risiko

8. Abschleppen/Transport/Lagerung



10. Erläuterung der verwendeten Piktogramme

Elektrohybridfahrzeug mit flüssigen Kraftstoffen der Kl. 2				
Smart-Schlüssel entfernen		Motorhaube		IR-Wärmebildkamera benutzen
Entzündbar		Gesundheitsschädlich		Umweltgefährlich
Schutzhandschuhe 	Gesichtsschutz 	Atemschutzausrüstung 	Mit Wasser löschen 	Nicht aufbrechen! Nicht öffnen!