

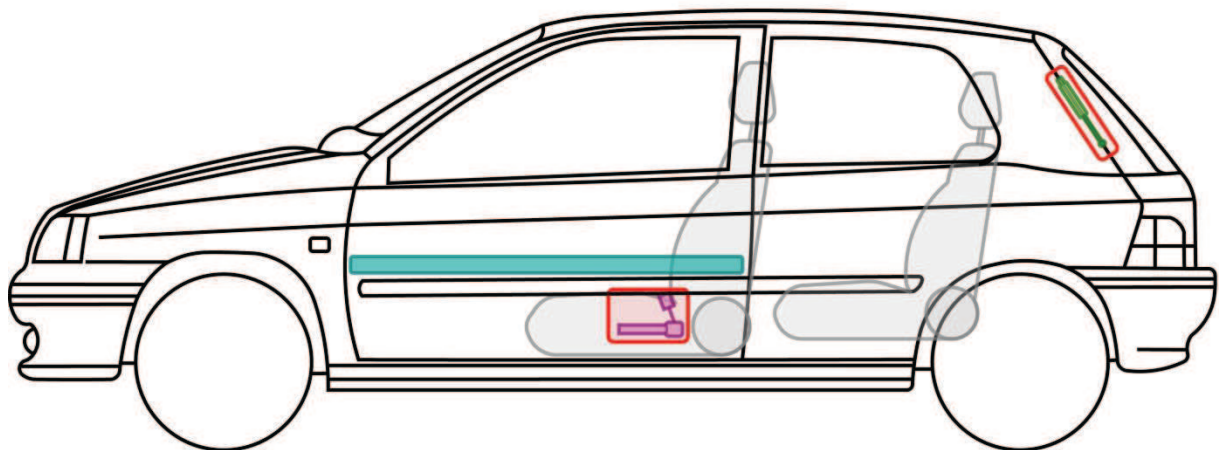

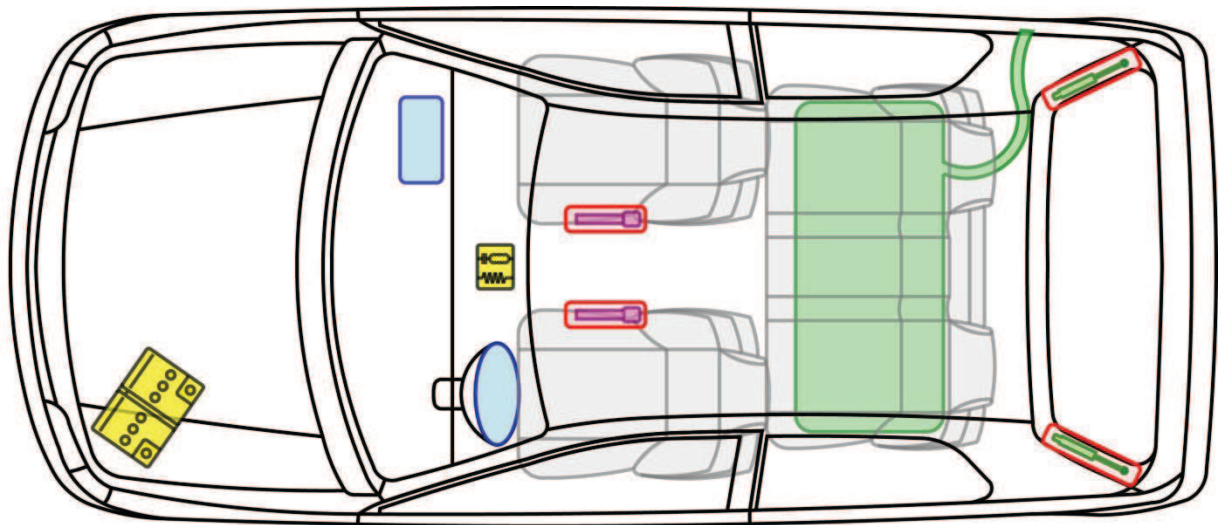









# CLIO I 3-Türer

TYP: 57, 1994-1998



## Legende

	Airbag		Karosserie- verstärkung		Steuergerät
	Gas- generator		Überroll- schutz		Batterie
	Gurt- straffer		Gasdruck- dämpfer		Kraftstoff- tank







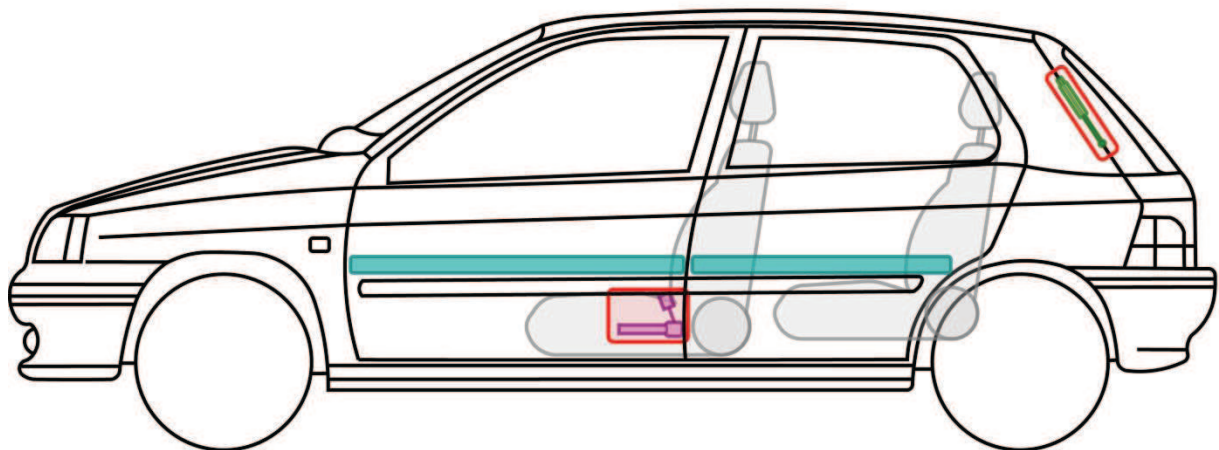
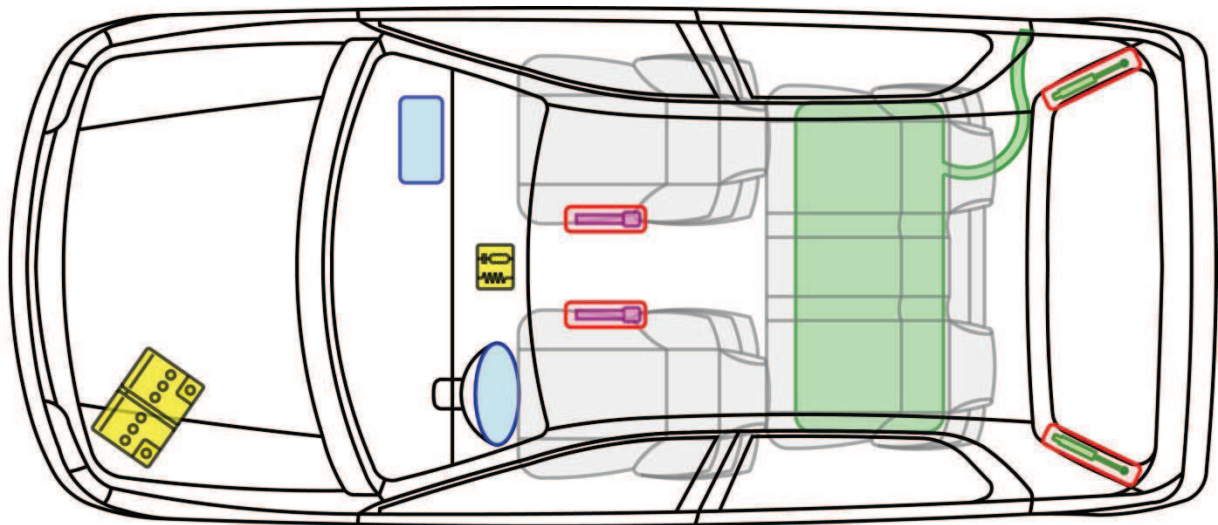



# CLIO I 5-Türer

TYP: 57, 1994-1998



## Legende

	Airbag		Karosserie- verstärkung		Steuergerät
	Gas- generator		Überroll- schutz		Batterie
	Gurt- straffer		Gasdruck- dämpfer		Kraftstoff- tank