

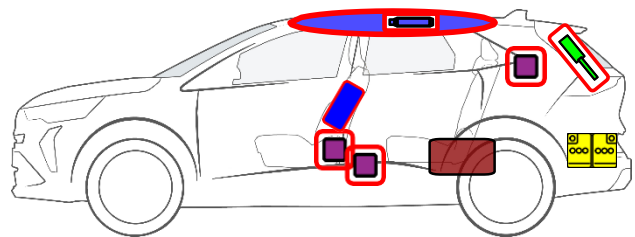

RENAULT

Symbioz E-Tech Full Hybrid

(2024 -)

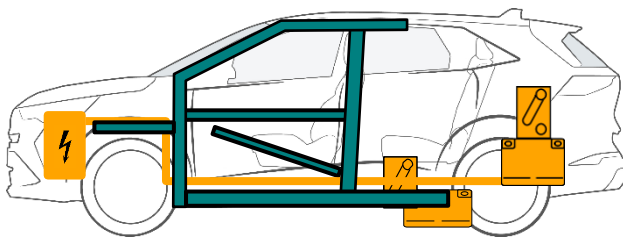
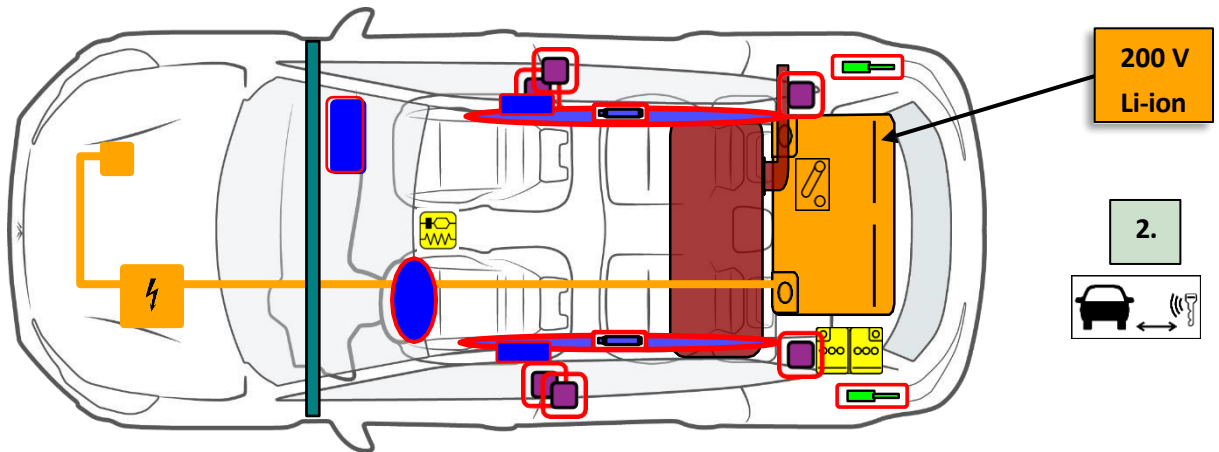

	Airbag		Gasgenerator		Gurtstraffer		SRS Steuergerät		
	Niedervolt-Batterie		Gasdruckdämpfer / vorgespannte Feder		Karosserie-Verstärkung		Bereich Bedarf besonderer Aufmerksamkeit		Benzin-/Ethanol-Kraftstofftank
	Hochspannungsbatterie		Hochspannungskabel		Hochvolt-Trennstelle		Hochspannungskomponente		

In Zusammenarbeit mit



MINISTÈRE DE L'INTÉRIEUR

Interne Bezeichnung	Datum	Version	Seite 1 / 4
RS-DJB HEV-2024	06/06/2024	1	

1. Identifizierung/Erkennung

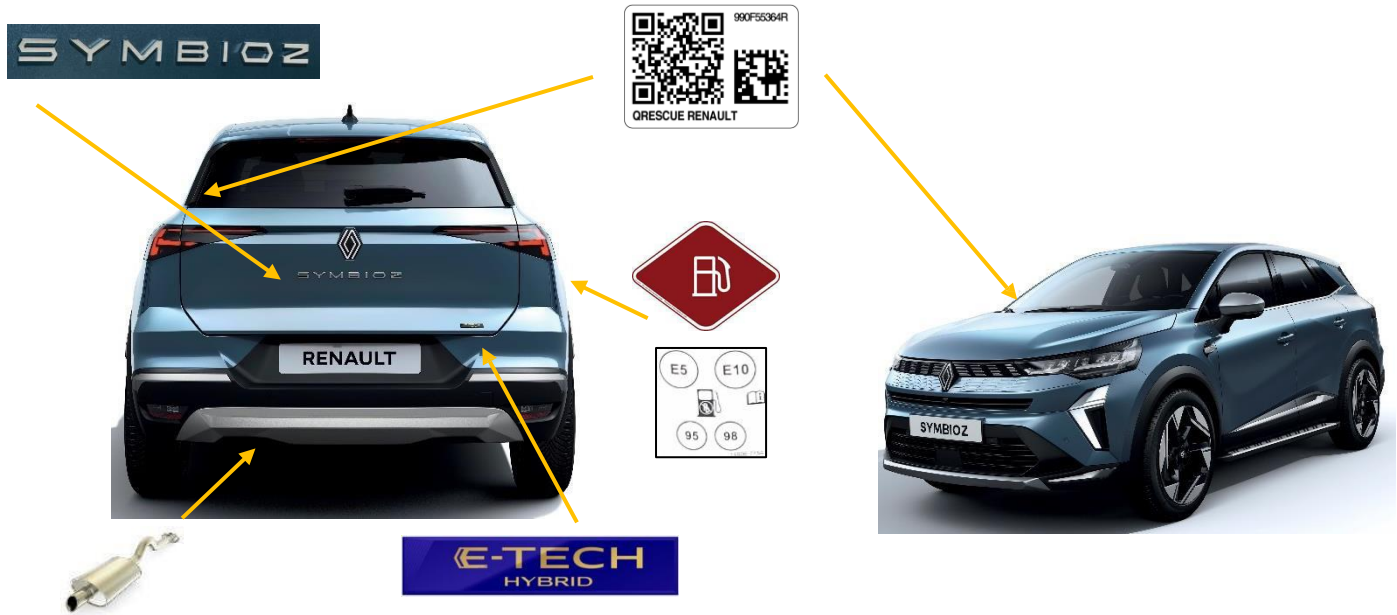

2. Immobilisieren/Stabilisieren/Anheben

Motorstillstand

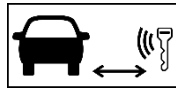

Hier nicht anheben/aufsetzen!

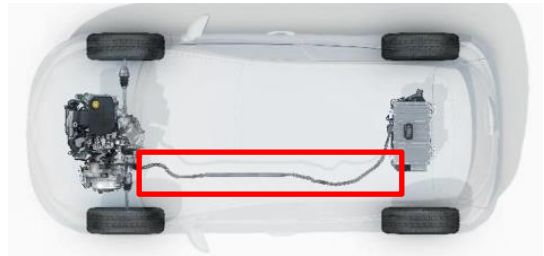

Bereich mit orangefarbenen Kabeln

3. Direkte Gefahren ausschalten/Sicherheitsbestimmungen

12 Volts Battery

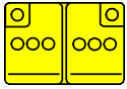

Bei Airbagauslösung schaltet sich die 12V-Batterie automatisch aus

Interne Bezeichnung	Datum	Version	Seite
RS-DJB HEV-2024	06/06/2024	1	2 / 4

200 V-Batterie

Nur im Rettungs-/Bergungsfalle! :

Abschalten der 200 V-Batterie: Service-Plug entfernen

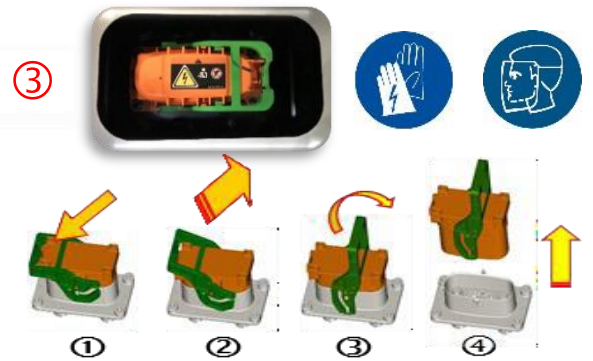
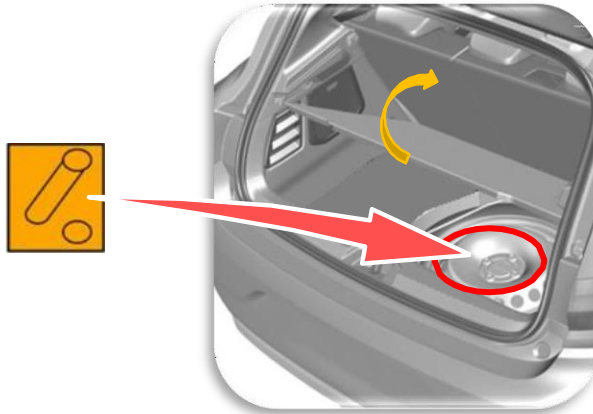

4. Zugang zu den Insassen

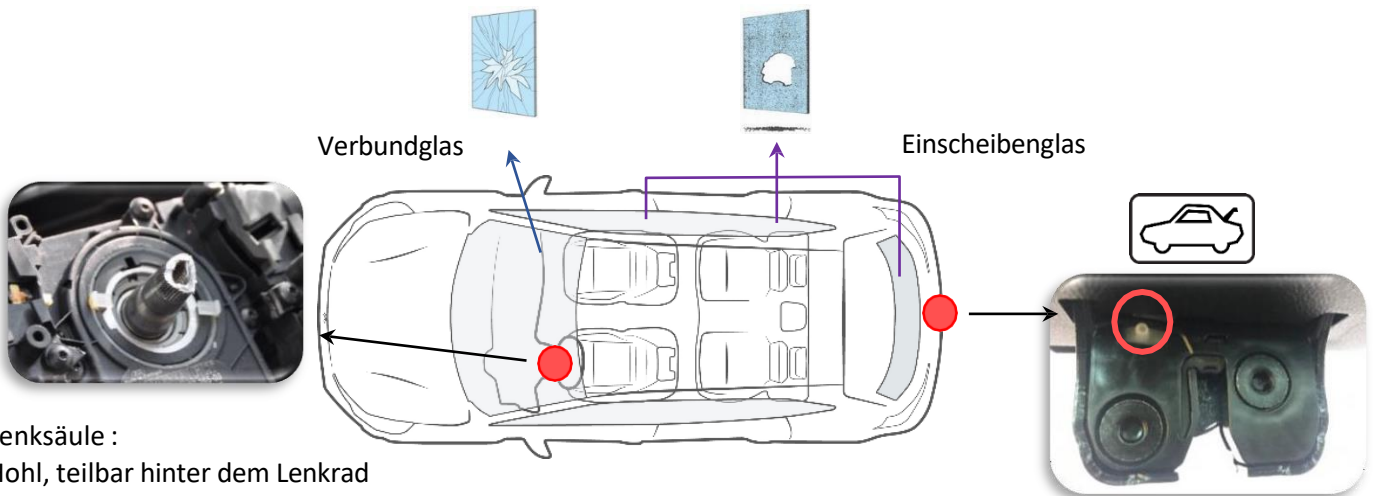

Lenksäule :
Hohl, teilbar hinter dem Lenkrad

Interner Knopf zum manuellen Öffnen

MÖGLICHE SITZNEIGUNG

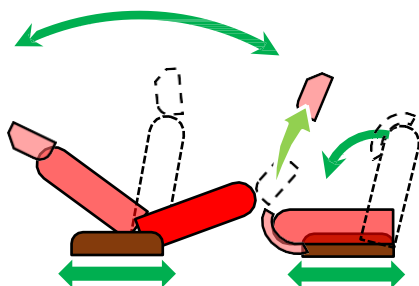

HOCHELASTISCHER STAHL

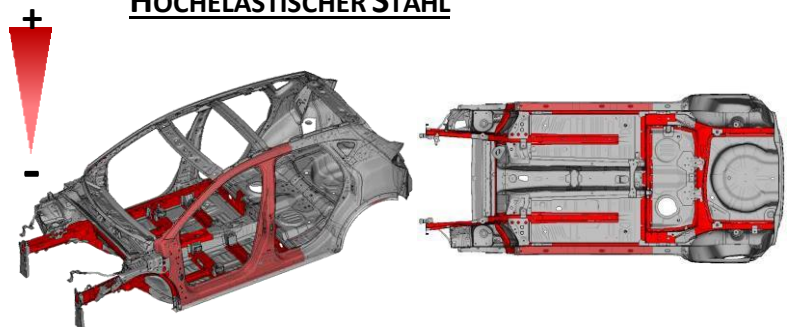

In Zusammenarbeit mit





MINISTÈRE DE L'INTÉRIEUR

Interne Bezeichnung	Datum	Version	Seite
RS-DJB HEV-2024	06/06/2024	1	3 / 4

5. Gespeicherte Energie/Flüssigkeiten/Gase/Feststoffe

	Lithium-Ion	1,2 kW.h	200 V	Casing Aluminium
---	-------------	----------	-------	------------------

			48 L
---	---	---	------

6. Im Brandfall

Löschen eines Brandes der Antriebsbatterie



GASDRUCKDÄMPFER



Explosionsgefahr durch Gasdruckdämpfer!

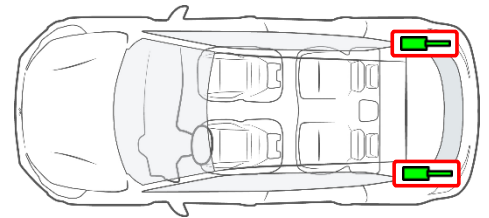

7. Im Falle des Untertauchens



Kein elektrisches Risiko

Nachdem Sie das Fahrzeug aus dem Wasser genommen haben :
Abschalten der 200 V-Batterie: Service-Plug entfernen

10. Erläuterung der verwendeten Piktogramme

 Elektrohybridfahrzeug mit flüssigen Kraftstoffen der Kl. 2				
 Smart-Schlüssel entfernen		 Kofferraum		 IR-Wärmebildkamera benutzen
 Entzündbar		 Gesundheitsschädlich		 Umweltgefährlich
Schutzhandschuhe 	Gesichtsschutz 	Atemschutzausrüstung 	Mit Wasser löschen 	Nicht aufbrechen! Nicht öffnen! 