

RENAULT AUSTRAL E-TECH FULL HYBRID

200 HP



1st October 2024

a new hybrid vision of the SUV

Renault Austral E-Tech full hybrid is a game changer: esprit Alpine version, with 2 x 12" openR screens, 9.3" head-up display⁽²⁾ and Google built-in services.



An innovative and immersive
experience awaits you on board
Renault Austral E-Tech full hybrid.

**200 hp E-Tech
full hybrid
engine**

**up to 30
advanced driver-
assistance
systems⁽²⁾**

**2x12" openR
screens, with
Google built-in**

**555 L⁽¹⁾
of boot
volume**

**9.3" head-up
display⁽²⁾**

**from 105g CO₂
and up to
60.1 mpg**

(1) according to VDA protocol.
(2) depending on version.

interactive menu

01. design

02. driving pleasure

03. driving experience

04. multimedia

05. interior space

06. advanced driver-assistance systems

07. customisation

PDF to be downloaded



equipment and engines



accessories

athletic design

Wide shoulders and a muscular bonnet for an intensely proportioned design. The glossy black⁽¹⁾ roof highlights the elegance of the lines. Contrasting side protection elements⁽¹⁾ reinforce the dynamic silhouette.



Arising from the historic collaboration between the Renault and Alpine design teams, the esprit Alpine version asserts its dynamic character: 20" daytona black diamond-cut wheels, exclusive matte shadow grey colour⁽²⁾, matte grey F1 blade at the front, glossy black roof, flush roof bars and distinctive badging.



20" daytona black diamond-cut alloy wheels with smoky grey clearcoat



esprit Alpine badge

The esprit Alpine Alcantara® fabric upholstery is enhanced with blue top-stitching, the headrests feature exclusive embroidered motifs, and the aluminium pedal unit energises the cockpit. As a final touch, the textured Alcantara® coated steering wheel has blue, white and red stitching.

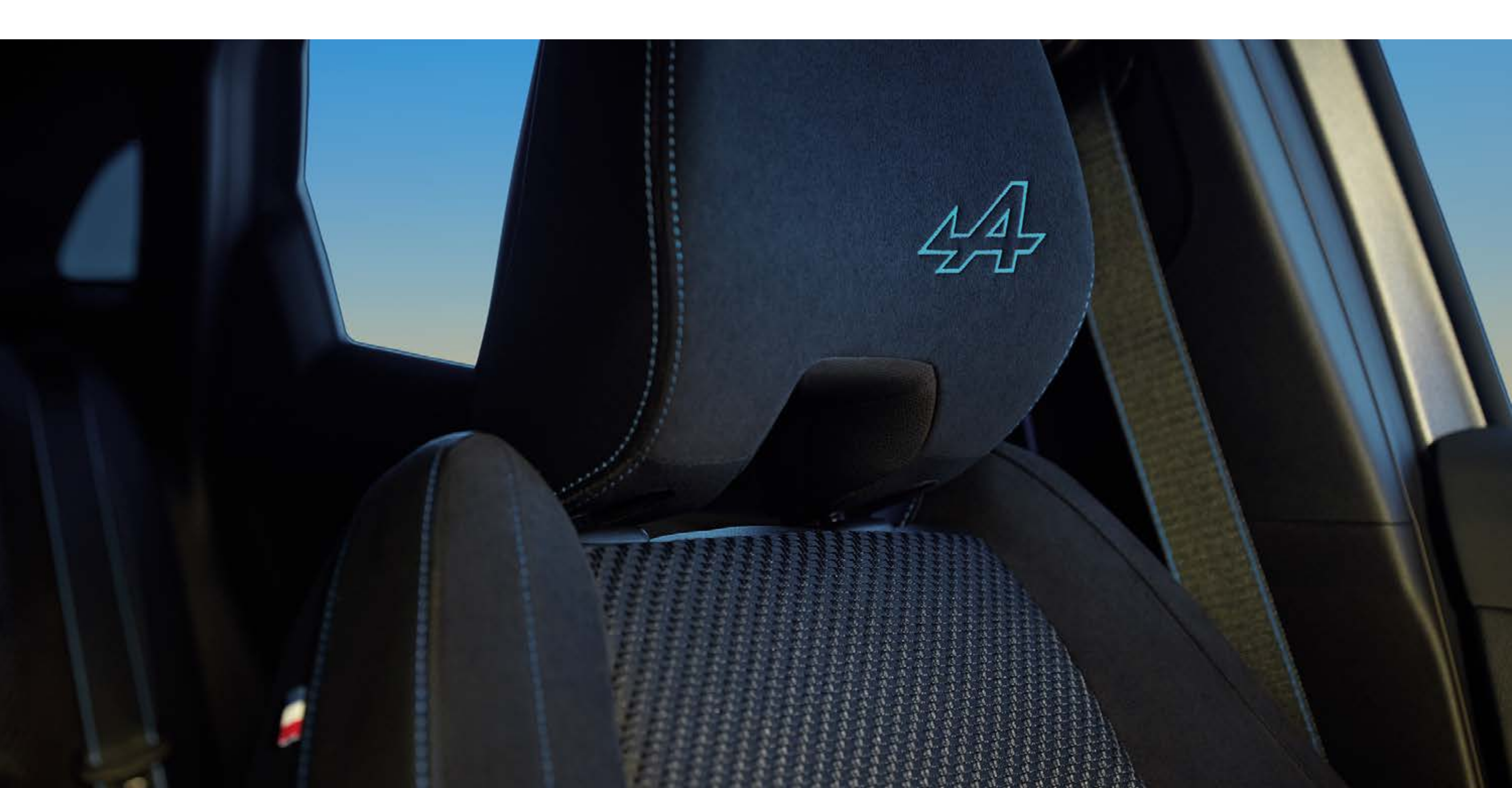

(1) depending on version.

(2) available on esprit Alpine versions.

build yours →

02. driving pleasure

the best of the hybrid

E-Tech
full hybrid

E-Tech
200 hp

up to
683 miles
of range⁽²⁾

up to
60.1mpg
fuel consumption⁽¹⁾

from
105 g/km
CO₂ emissions⁽¹⁾



Discover our 100% hybrid range with the E-tech full hybrid engine: one of the most efficient in its category.

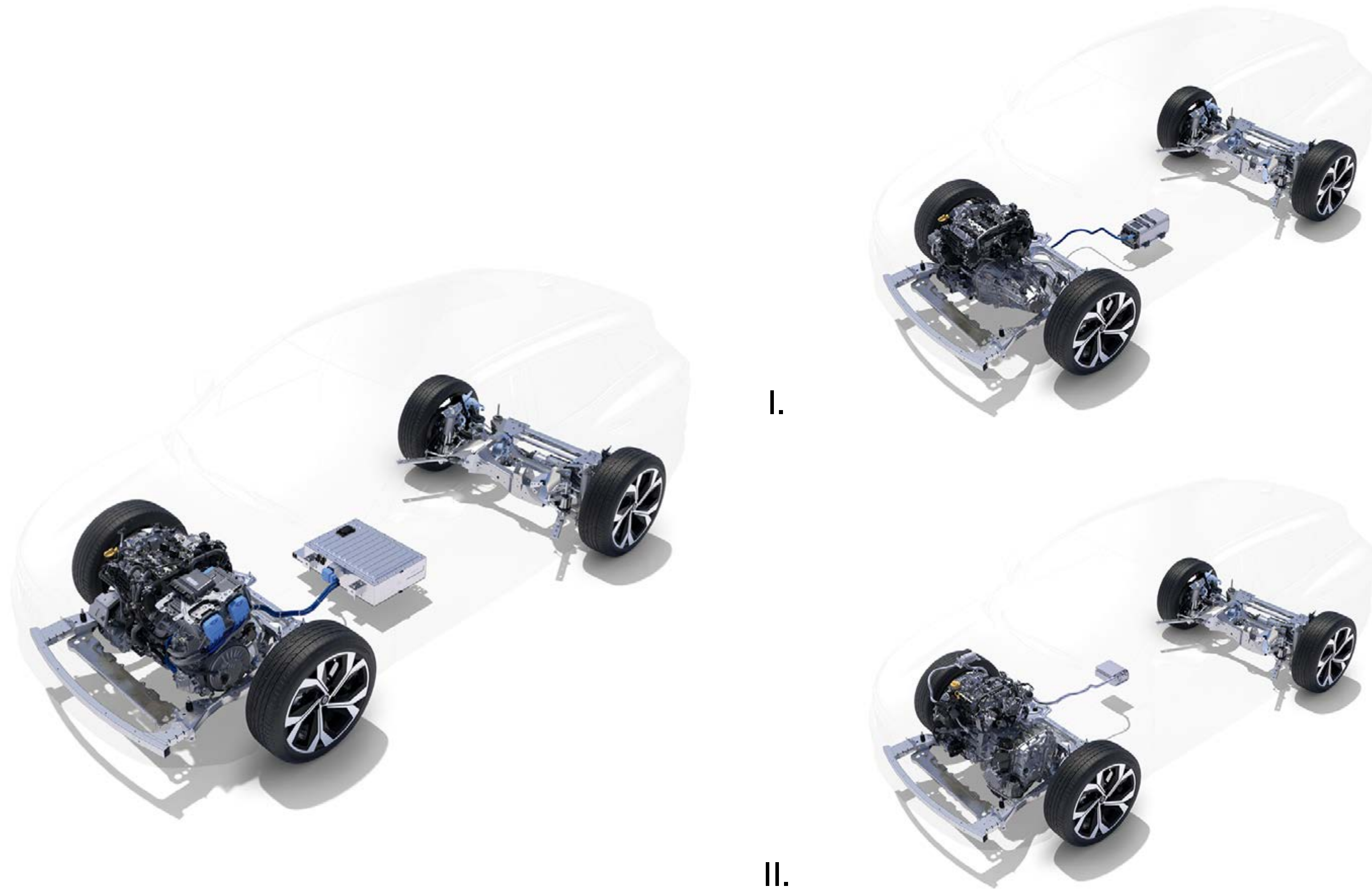

The battery recharges during deceleration and braking: no need to plug in to recharge.

	E-Tech full hybrid 200
technology	400V battery + 2 electric engines + 1 internal combustion engine
fuel consumption⁽¹⁾	up to 60.1 mpg
CO₂ emissions⁽¹⁾	from 105 g/km
energy recovery via deceleration and braking	yes
management of the level of energy recovery	yes
electric assistance to the internal combustion engine	yes

(1) values type-approved according to version/in accordance with WLTP protocol / UTAC source/July 2022.
(2) up to 1,100 km of driving range with a full tank of petrol according to WLTP data.

build yours →

on-board technologies

To optimise the driving experience, the controls are oriented towards the driver and the most important information is directly beneath their eyes and in the drivers eye line with the head-up display⁽¹⁾.



Don't take your eyes off the road: the new 9.3" head-up display⁽¹⁾ projects essential information on to the windscreen.



find your speed, driver-assistance systems and navigation on the head-up display⁽¹⁾

Engine response and sound, steering firmness, ambient lighting and driver screen configuration. With multi-sense, customise your vehicle with up to 4 driving modes available for a unique driving experience.



sport mode: intense driving pleasure



eco mode: optimised fuel consumption.

other modes available are:
comfort mode: combines safety and driving comfort
perso mode: a fully customisable driving experience

(1) depending on version.

high-fidelity sound Harman Kardon⁽¹⁾

Enjoy an immersive sound experience with the new and exclusive Harman Kardon⁽¹⁾ system that delivers 485 watts of power through 12 speakers positioned around the passenger compartment.

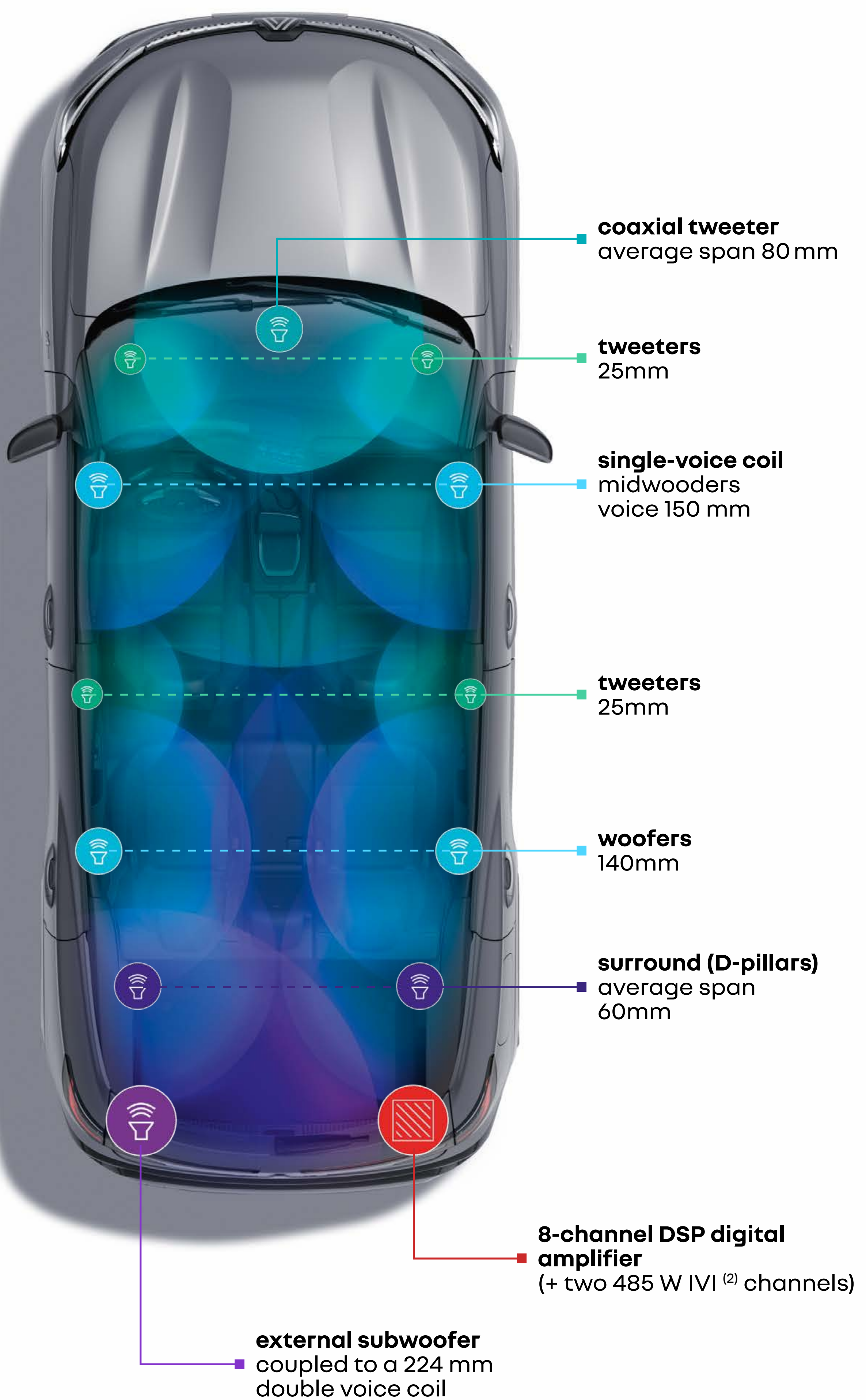

(1) depending on version.

(2) on-board Infotainment (IVI).

build yours →

openR link multimedia system with Google built-in

The openR link multimedia system and its 2x12" of digital display of intuitive technology incorporate the best My Renault connected services and with Google⁽¹⁾ built-in.



Amazon Music, EasyPark, Radioplayer... more than 50 applications⁽¹⁾ with exclusive content are available via Google Play⁽²⁾.



Waze is a community-based navigation app that shares information in real time. Waze boosts your peace of mind.

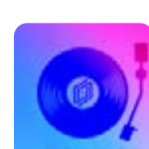

Drive to the beat with our new musical game – **SongPop for Renault**. Play together and rediscover popular songs with your family and friends!



Take to the road while listening to playlists, and much more, with **Amazon Music**, included with your Amazon Prime subscription.



If **Spotify** is more your bag, download the app to listen to your favourite music or podcasts.



Vivaldi browser is an efficient, fast web browser that respects your privacy.



Access all your favourite radio stations live, at any time, in France or abroad, with **Radioplayer**.

“Hey Google...” Talk to Google to plan a journey, change driving mode or adjust the temperature. The voice assistant⁽¹⁾ is always available.

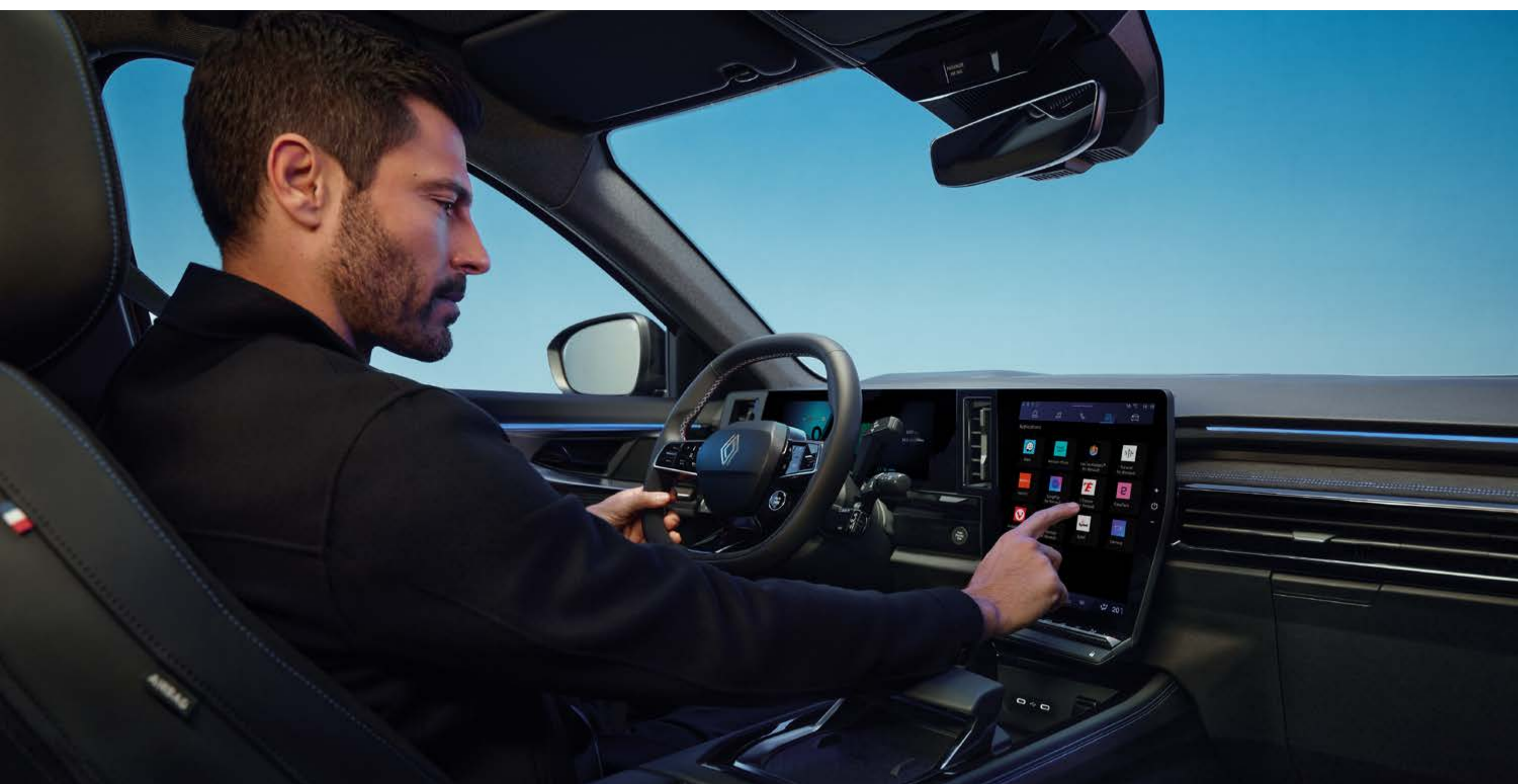

Blocked road, new one-way street, temporary deviation... The Google Maps navigation system⁽¹⁾ ensures precise driving even in the event of network loss.



- (1) My Renault, Google Maps and Google Assistant connected services are provided free of charge for 5 years from the date of delivery of your vehicle.
(2) using applications downloaded from Google Play requires a dedicated data package. To use these apps, share your phone's connection with your Renault. You can also subscribe to a pay-as-you-go offer from our partner Orange (offer without commitment) where the first 3 GB are free (valid for 6 months).
Google, Google Maps, Google News, Waze and other brand names are all trademarks of Google LLC.

build yours →

05. interior space

comfort and modular design

A generous amount of legroom providing ultimate comfort. The rear bench slides up to 16cm, giving a larger boot when you need it.



panoramic sunroof on iconic esprit Alpine

Get up to 1,525 L of boot volume by folding down the rear seats.



place your foot underneath the boot sill and it opens automatically thanks to the hands-free motorised tailgate⁽¹⁾



hand rest and wireless smartphone charger⁽¹⁾

⁽¹⁾ version dependant

build yours →

06. advanced driver-assistance systems

up to 30 advanced driver-assistance systems⁽²⁾

Renault Austral E-Tech full hybrid offers up to 30 advanced and innovative driver-assistance systems.

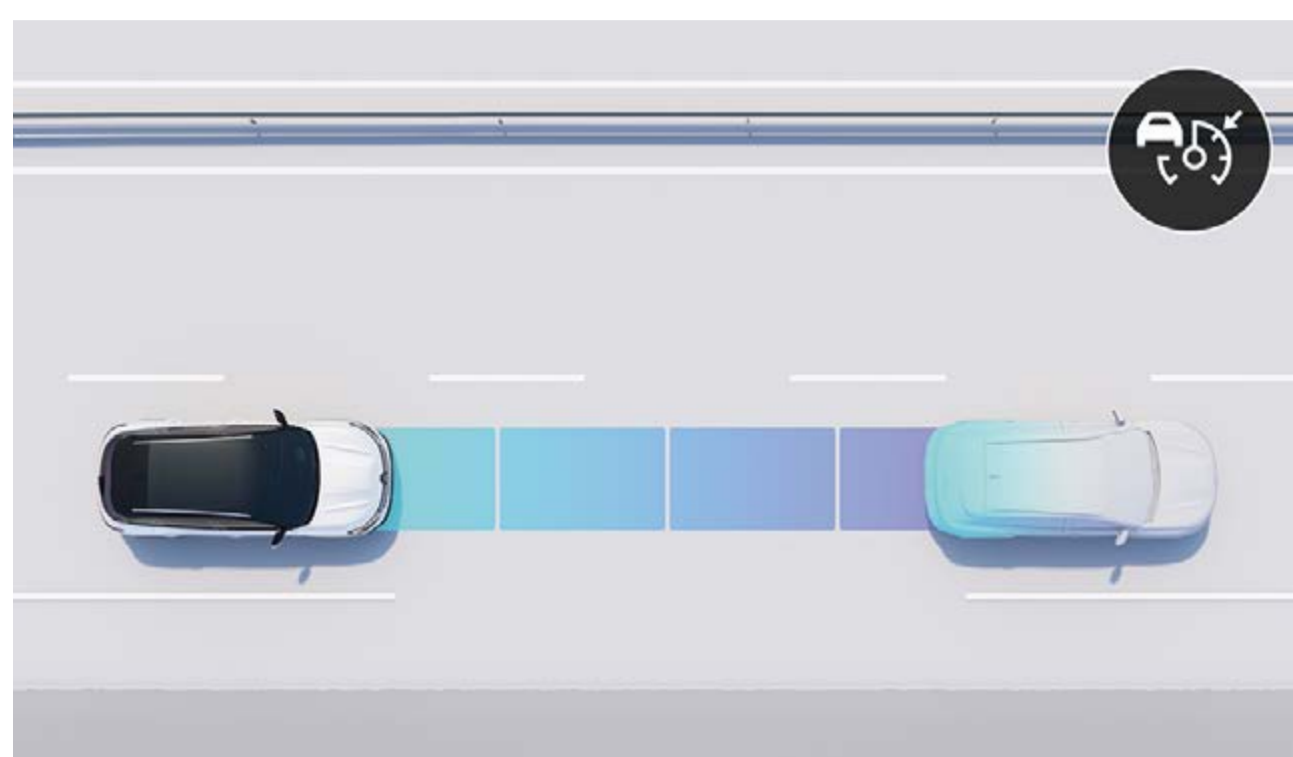

adaptive cruise control

It maintains a safe distance between you and the vehicle in front by activating the brakes when the distance is too short and the accelerator when the road is clear again.



Matrix Vision LED headlights

The system automatically adjusts the light beam shape to the traffic and weather conditions to avoid glare and optimise night vision.



emergency braking when reversing

This system detects obstacles at the rear and stops the vehicle automatically in the event of risk of collision.

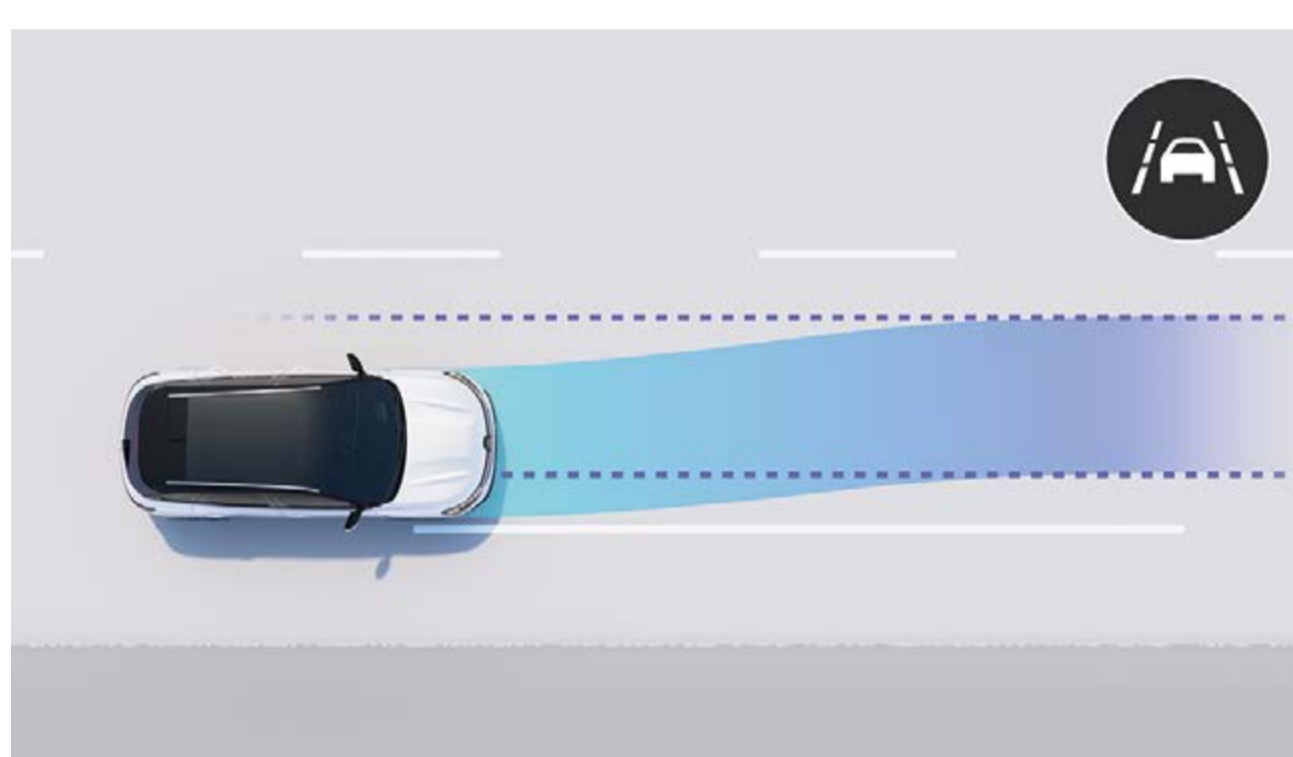

lane keeping assist

This corrects the angle of the steering wheel, returning the vehicle to its lane unless you have indicated.



360° view 3D camera

4 cameras, whose images recreate the vehicle's direct environment 360° around it, allow you to perform your manoeuvres effortlessly.

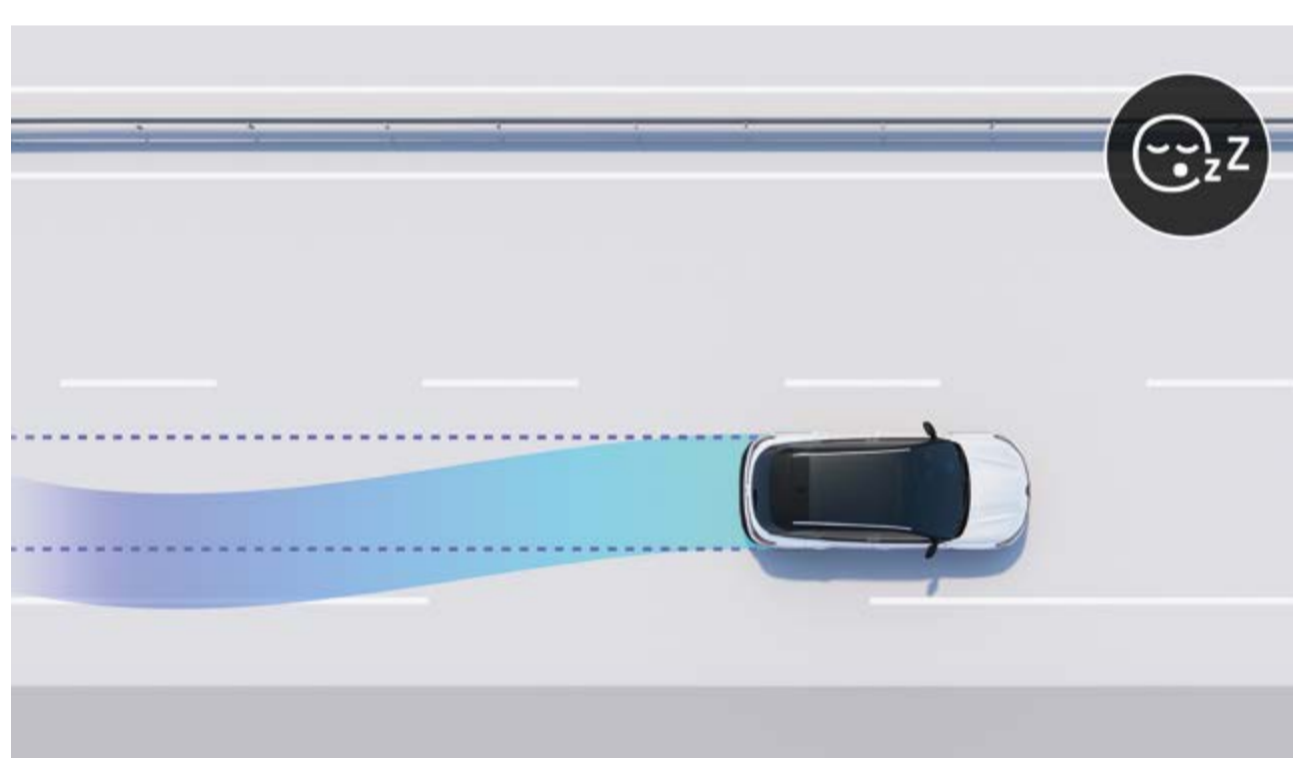

driver attention alert with drowsiness warning

This system warns the driver if fatigue is detected via an audible alert and a message on the dashboard, detection is based on analysis of the driver's reactions.

driving

- active driver assist
- hill start assist
- 9.3" head-up display (210 cm²)
- distance warning alert
- cruise control
- adaptive cruise control
- automatic wipers

parking

- rear parking sensors
- front parking sensors
- side parking sensors
- 360° view 3D camera
- rear view camera
- hands-free parking

safety

- lane change warning
- lane departure warning
- lane keeping assist
- blind spot warning
- emergency brake assist with intersection function
- automatic emergency braking when reversing
- city/suburban automatic emergency braking with pedestrian/cyclist detection
- rear cross parking prevention
- lane departure prevention in the event of overtaking
- intelligent speed assist: road sign recognition / road sign recognition with speed alert
- front cross traffic alert
- rear cross traffic alert
- driver attention alert with drowsiness warning
- emergency lane keep assist including overtaking & oncoming traffic

lighting

- LED Matrix Vision headlights
- automatic main-beam/dipped headlights activation
- adaptive vision LED headlights (with integrated fog light function)

(1) included for 5 years. (2) depending on version.

build yours →

07. customisation

colours



arctic white (non-m)



flame red (mp)



diamond black (mp)



iron blue (mp)



shadow grey (mp)



matte shadow grey (only available with diamond black roof) (m)⁽¹⁾

non-m: non metallic paint.

m: matte paint.

mp: metallic paint.

(1) available only on the esprit Alpine versions.

photos not contractually binding.

build yours →

07. customisation

interior trims



techno

- 19" komah black diamond-cut alloy wheels
- matrix LED vision headlights
- Google built-in
- 9.3" head-up display
- wireless phone charger



techno esprit Alpine

- 20" daytona black diamond-cut alloy wheels
- heated & electric front driver & passenger seat
- electric power boot with handsfree opening
- esprit Alpine styling
- heated steering wheel



iconic esprit Alpine

- 360° around view camera
- hands-free parking
- Harman Kardon audio system
- panoramic sunroof

using applications downloaded from Google Play requires a dedicated data package. To use these apps, share your phone's connection with your Renault. You can also subscribe to a pay-as you-go offer from our partner Orange (offer without commitment) where the first 3 GB are free (valid for 6 months). Google, Google Maps, Google News, Waze and other brand names are all trademarks of Google LLC. photos not contractually binding.



download the trims and equipment PDF (6 MB)

07. customisation

upholstery



leatherette & grey gradient fabric upholstery⁽¹⁾



esprit Alpine carbon fabric & Alcantara upholstery with blue stitching⁽²⁾

(1) standard on techno.

(2) standard on techno esprit Alpine & iconic esprit Alpine.

wheels



19" komah black diamond-cut alloy wheels⁽¹⁾



20" daytona black diamond-cut alloy wheels⁽²⁾

(1) standard on techno.

(2) standard on techno esprit Alpine & iconic esprit Alpine.
Alpine lettering not on wheels in the UK.

build yours →

07. customisation

accessories



customisation packs

Customise your vehicle's exterior trim with four colour packs: carbon effect, gold accents, light grey or satin metal grey.



touring pack

Roof bars 480L and roof box



towbars

Fully electric, swan neck and removable towbars available.

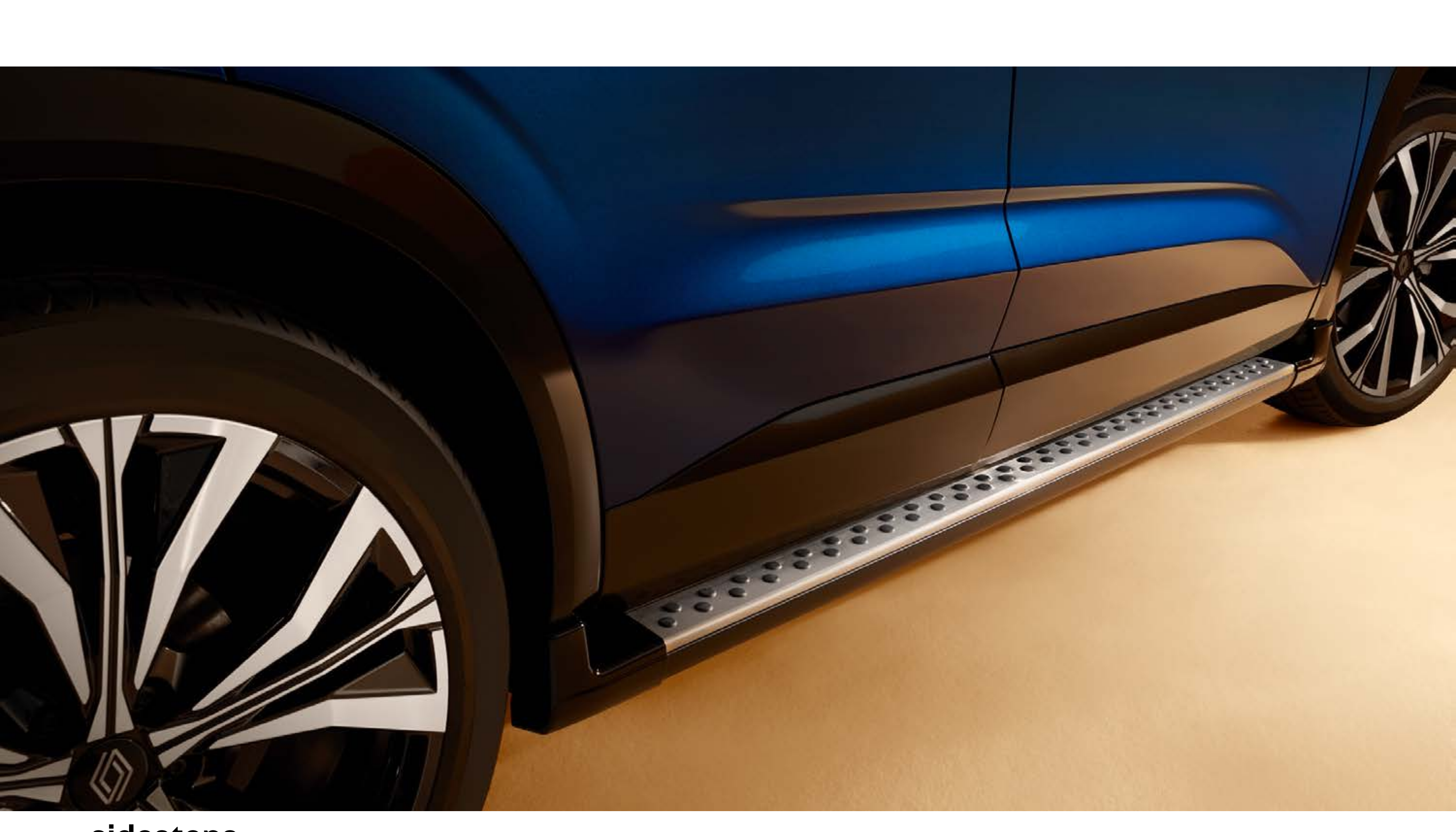

sidesteps

Emphasise the robust style of Renault Austral with the sidesteps which make it easier to access accessories on the roof and protect the bodywork from everyday shocks.



esprit Alpine textile floor mats

Choose from a full range of mats to protect your vehicle's passenger compartment.



pet pack

Separation grid and modular boot liner

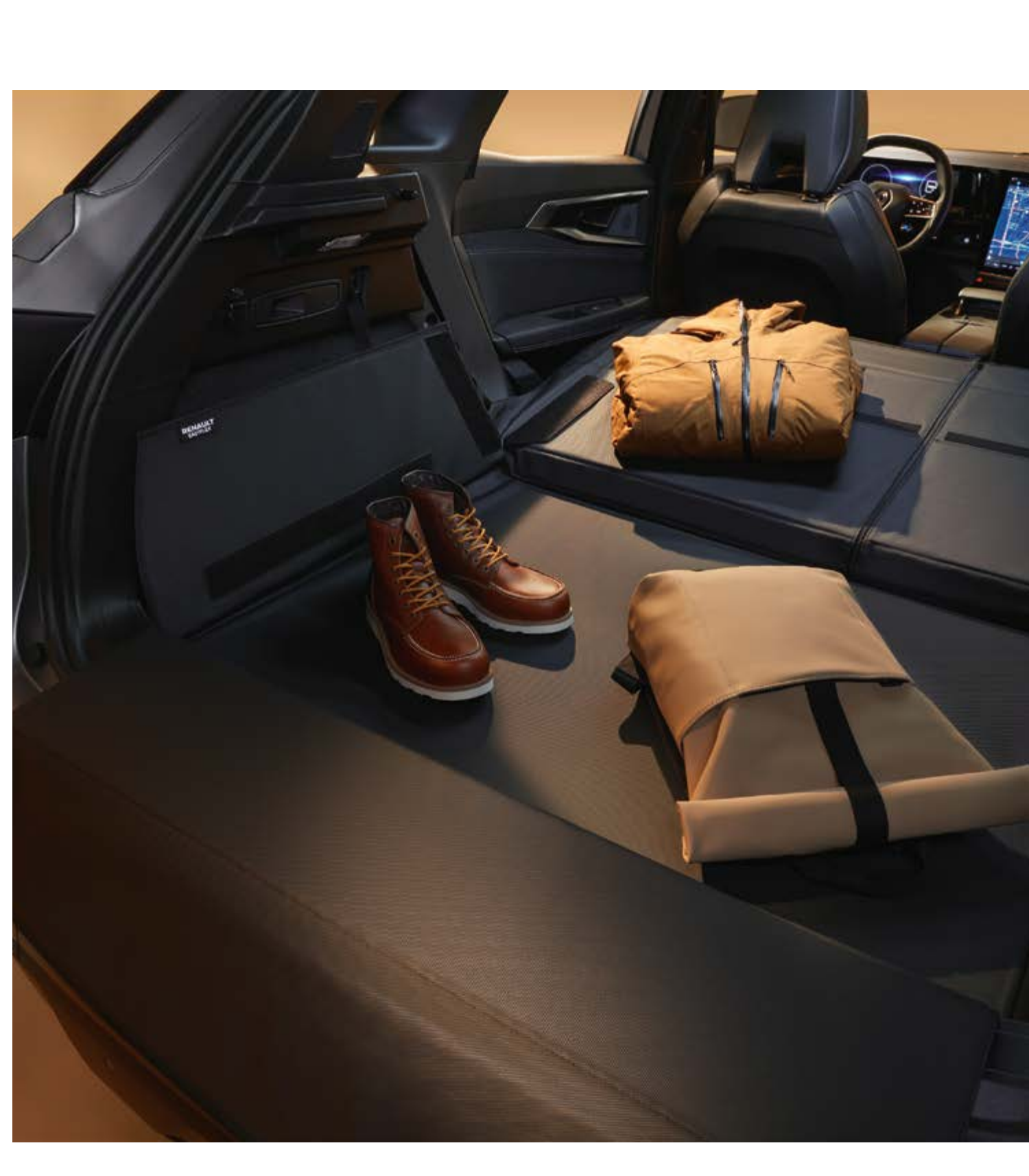

rubber mats



protection pack (techno)

Illuminated door sills, boot sill and boot liner

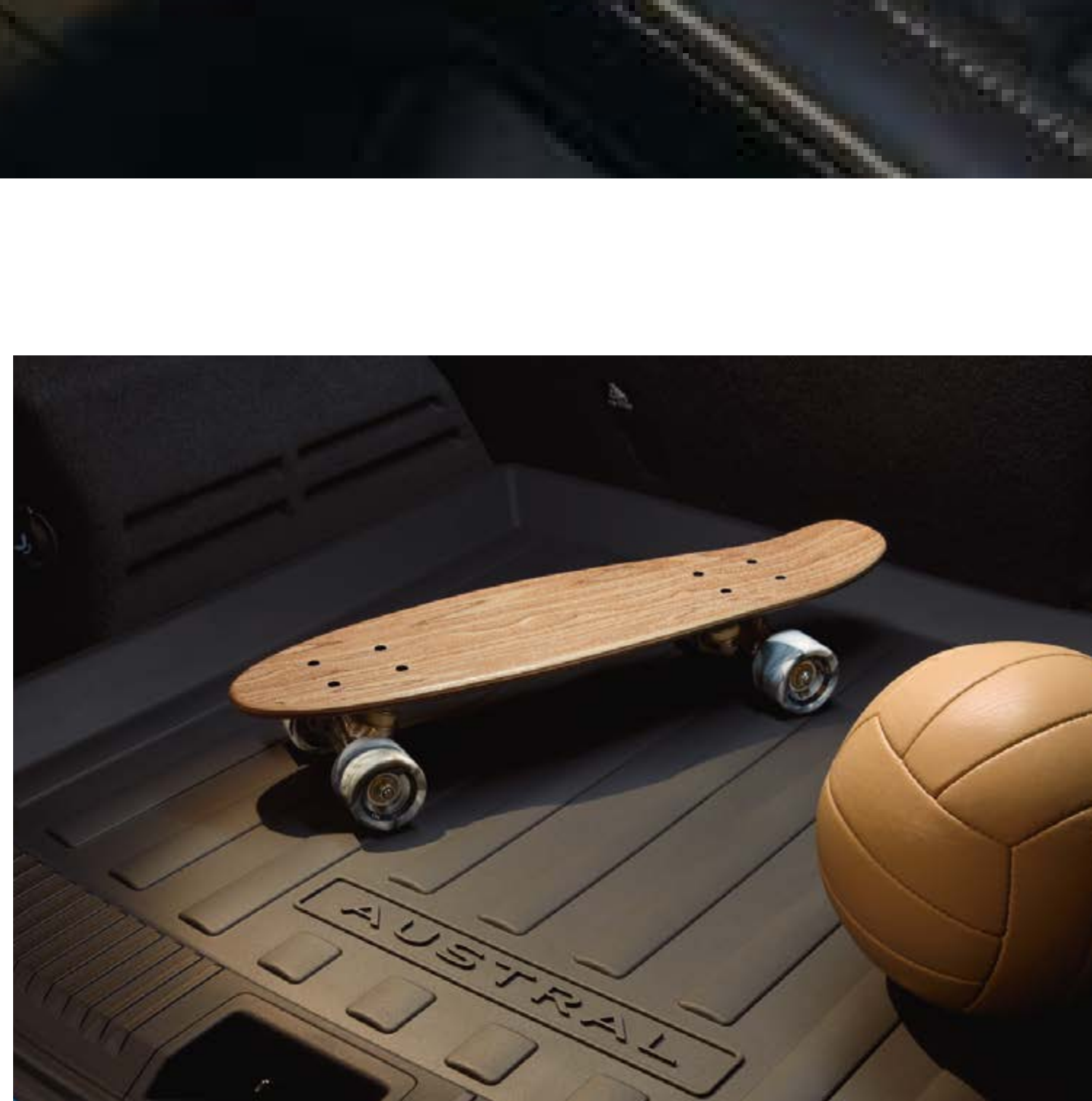

dash cam pack

Front and rear dashcam



spare wheel kit

Spare wheel kit and kit bag.



download the accessories brochure PDF (6 MB)

build yours →

07. customisation

engines

**E-Tech
full hybrid
200 hp**

energy

full hybrid
+ unleaded petrol (E10)

max. power kW EEC (hp) / engine speed of (rpm)

96 kW at 4,500 rpm
(internal combustion engine only)

max. torque (Nm EEC) / engine speed of (rpm)

205 N.m / 1,750 rpm

batteries

lithium-ion

performance

maximum speed (mph)

108

0-62mph (seconds)

8.4



**download the
engine PDF (6 MB)**

dimensions and volumes

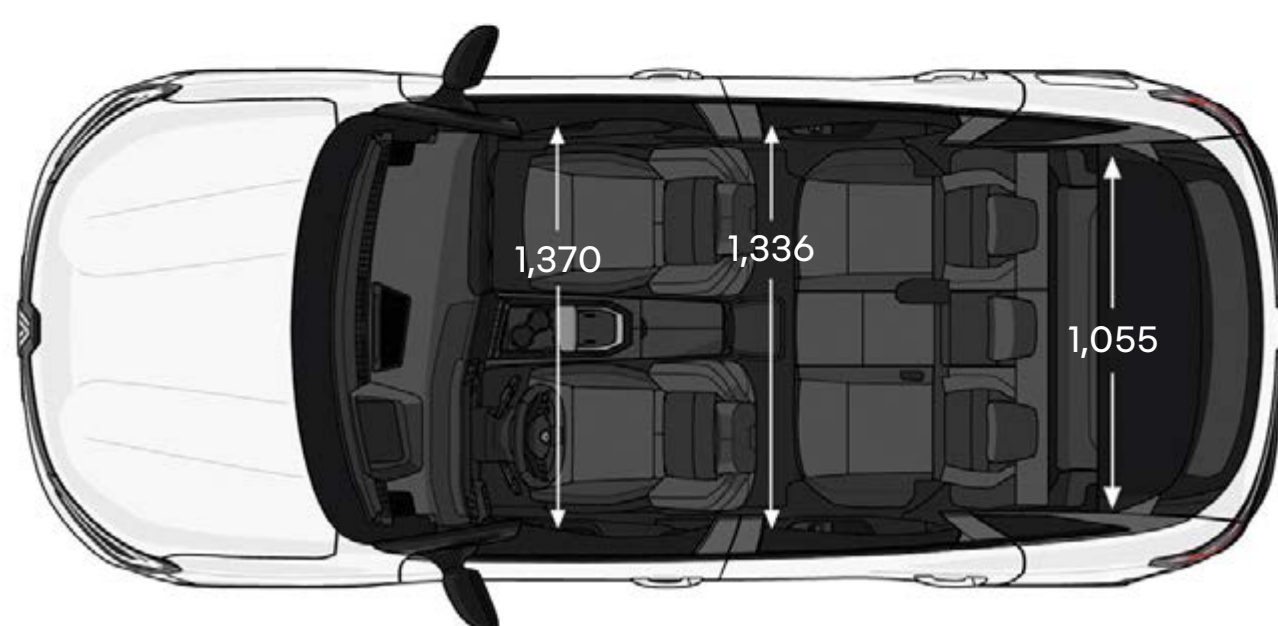
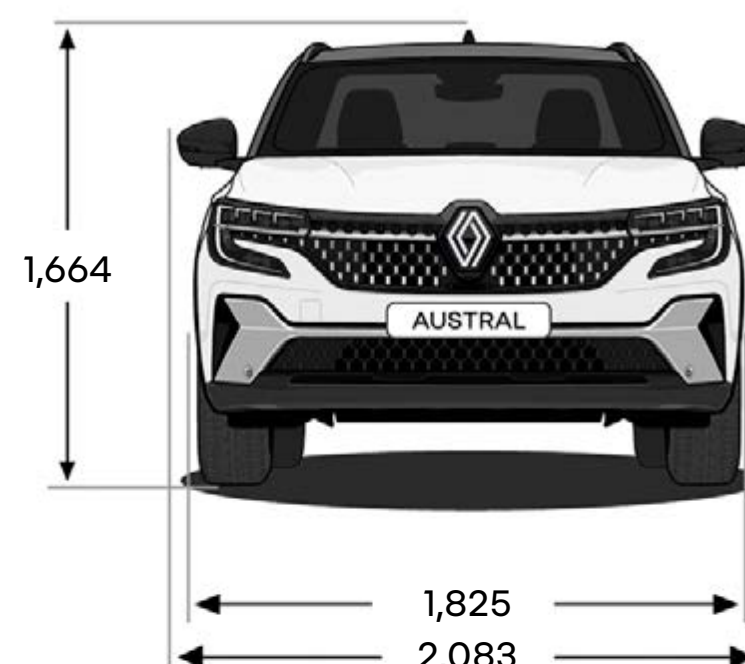
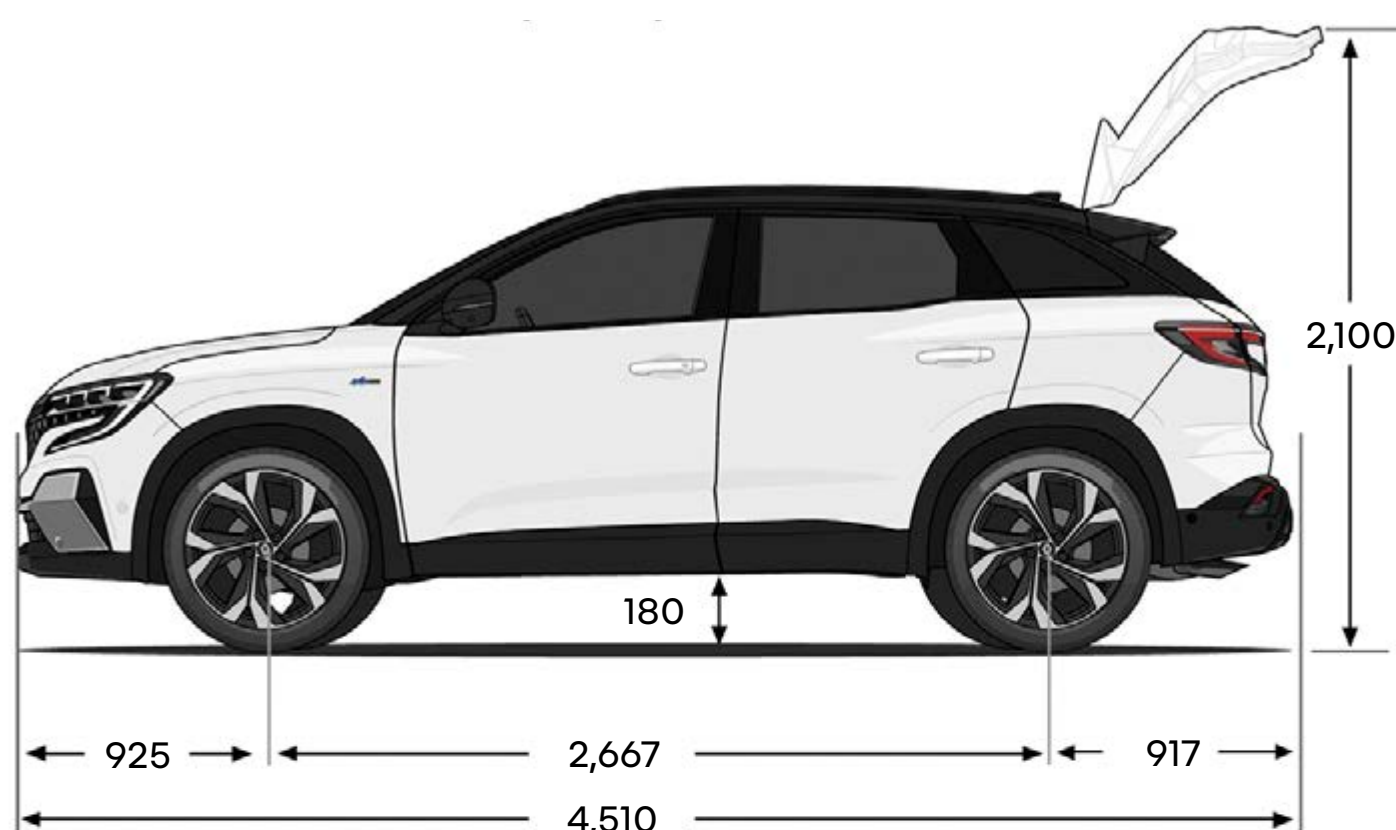

dimensions in (mm).

Boot volume (in litres)

E-Tech full hybrid

boot capacity

555

boot capacity (with rear seats folded down)

1,525

build yours →

Renault care service

**Replace what is necessary,
at the right time. Thanks to
its connected and predictive
maintenance features, it is easy
to service your Renault Austral
E-Tech full hybrid. And thanks
to the My Renault application,
quotes, online appointments
and even service history are
at your fingertips.**

[find out more about Renault care service](#)



Every precaution has been taken to ensure that the contents of this brochure were accurate and up-to-date at the time of publication. This document has been created using pre-production and prototype models. In line with its policy of continuous product improvement, Renault reserves the right to modify the specifications, vehicles and accessories described and featured at any time. Any such modifications are communicated to Renault dealers as quickly as possible. Depending on the country of sale, versions may differ and some equipment may be unavailable (standard, optional or accessory). Please contact your nearest dealer for the latest information. For reasons to do with the medium, the colours featured in this document may differ slightly from those of the actual paintwork or interior trim. All rights reserved. Reproduction in any format and by any means of all or part of this brochure is prohibited without prior written authorisation from Renault.

Publicis - photo credits: P. McLean, © Renault Marketing 3D-Commerce - October 2024.
Renault s.a.s, a French simplified joint stock company with a share capital of €533,941,113.00 / 122-122 bis avenue du Général Leclerc - 92100 Boulogne-Billancourt Cedex, France - registered on the Trade and Companies Registry (R.C.S.) of Nanterre under number B 780 129 987 / tel.: 0806 00 20 20.

Renault recommends 



build yours →