

# RENAULT CLIO

available with  
full hybrid E-Tech



1 April 2026

# different energy, same love

**More Clio than ever after 30 years of success, Renault Clio full hybrid E-Tech injects new energy. The overhaul of the Renault identity is reflected in the sportiness of its esprit Alpine version and the sharper new grille. Inside are biobased and recycled materials, comfort and connectivity.**



**Enjoy a unique driving experience with the full hybrid E-Tech 145hp engine.**

**full hybrid E-Tech 145hp engine**

**up to 560 miles of driving range<sup>(1)</sup>**

**esprit Alpine version**

**biobased and recycled materials**

**301L of boot volume**

**up to 22 driver-assistance systems<sup>(2)</sup>**

(1) internal source. based on Clio E-Tech vs WLTP fuel consumption figures. figures shown are for comparability purposes only. actual real world driving results may vary depending on factors including the starting charge of the battery, accessories fitted after registration, weather conditions, driving styles and vehicle load. (2) Always follow road safety regulations. It is your responsibility to stay alert, drive safely and be in control of the vehicle at all times. You should not solely rely on driver convenience and assistance features. Some features may not work in all conditions and circumstances, and they have speed and other limitations.

# **interactive menu**

**01. design**

**02. driving pleasure**

**03. on-board experience**

**04. multimedia**

**05. advanced driver-  
assistance systems**

**06. customisation**

**download the PDF**



**equipment and engines**



**accessories**

## a new impetus

Renault Clio full hybrid E-Tech<sup>(1)</sup> unveils a distinctive and stimulating style: enlarged front grille with chrome, new full LED lights at the front and rear, and sculpted sides. The sportiness is expressed in every detail, with the esprit Alpine version and its shadow grey F1<sup>®</sup> blade.



The Nouvel R diamond logo and the half-diamond daytime running lights accentuate the modernity of the design, providing a bold and distinctive look.



In the esprit Alpine versions, the 17" F1 inspired diamond-cut alloy wheels enhance the model's sporty personality<sup>(2)</sup>.



The esprit Alpine interior stamps its identity, with the blue top-stitching on the upholstery, the embroidered motif on the upper seatback, the aluminium pedal unit and the Alpine door sill. The blue/white/red stitching on the steering wheel give a nod to the esprit Alpine DNA.

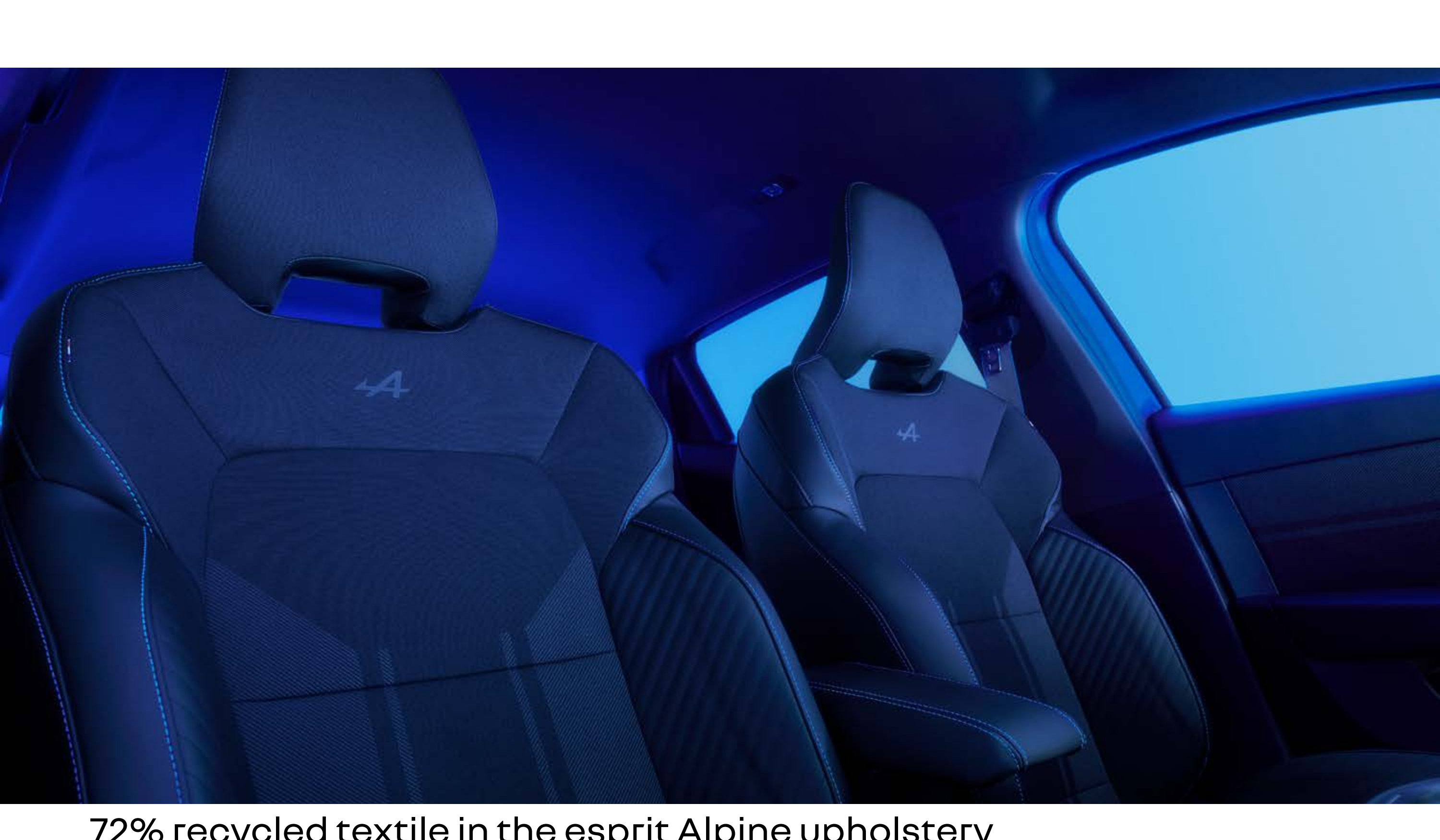

72% recycled textile in the esprit Alpine upholstery

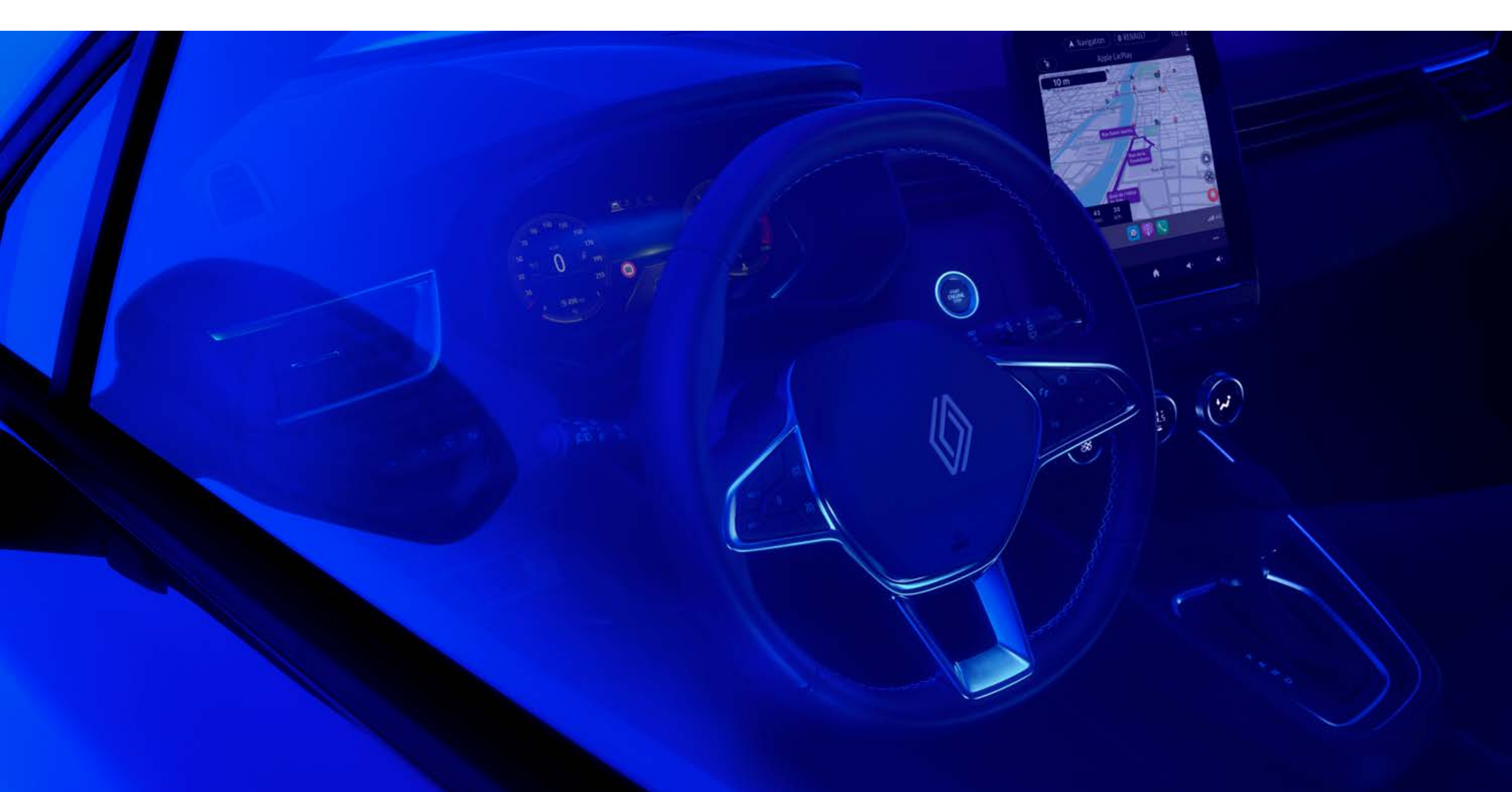

blue/white/red top-stitching on the steering wheel

(1) TCe90 also available. (2) blue centre cap or grey centre cap depending on body colour.

[configure and order →](#)

## 02. driving pleasure

# full hybrid E-Tech<sup>(1)</sup>

full hybrid  
**E-Tech**  
**145 hp**

up to  
**560 miles**  
of driving range<sup>(2)</sup>

up to  
**65.7 mpg**  
fuel consumption<sup>(3)</sup>

from  
**98 g/km**  
CO<sub>2</sub> emissions<sup>(3)</sup>



**In town, the electric driving allows you to achieve up to 40% fuel savings<sup>(4)</sup>. The battery recharges during deceleration and braking.**

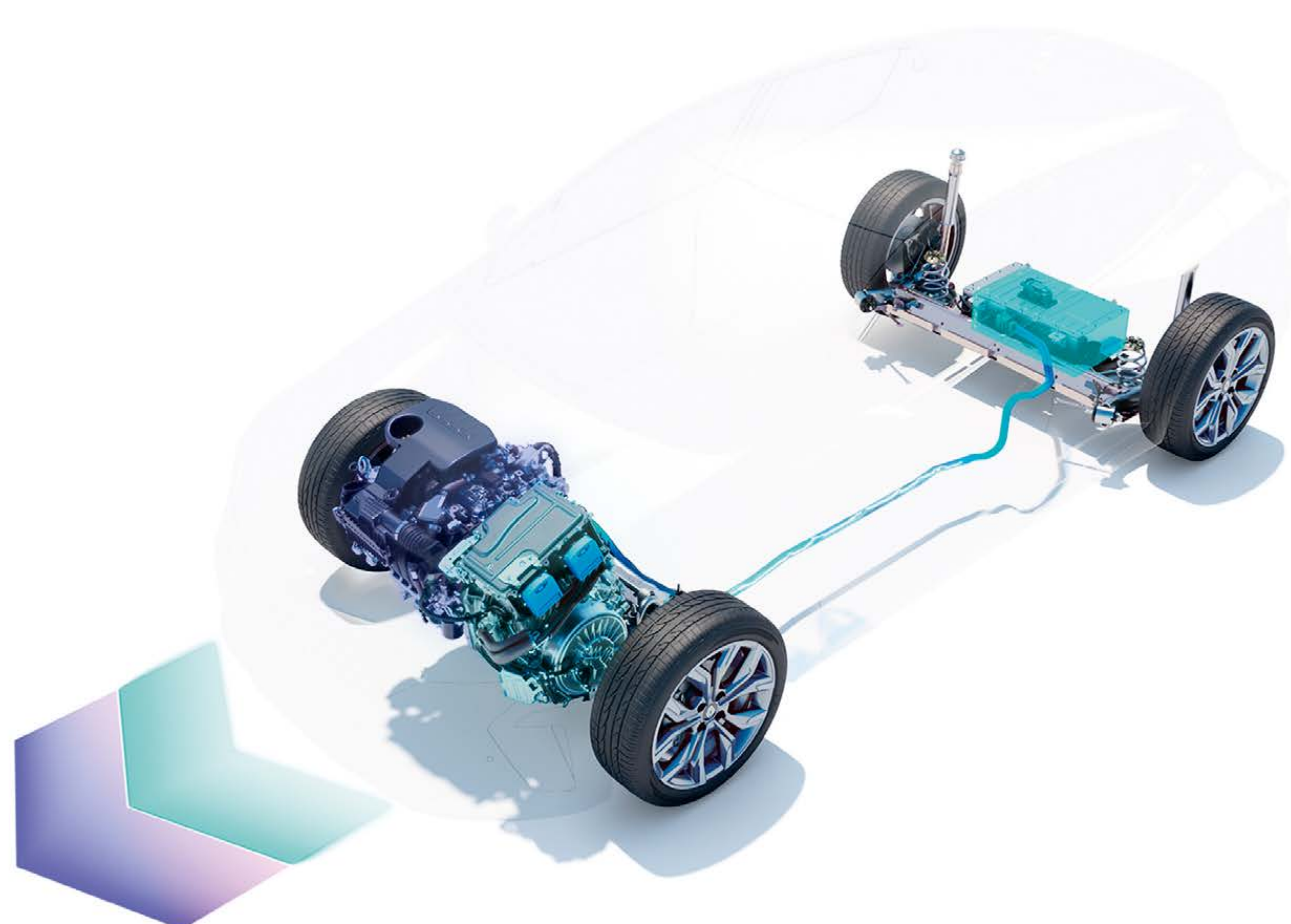

(1) TCe90 also available.

(2) up to 560 miles range with a full tank, according to WLTP data for full hybrid E-Tech versions.

(3) 64.2 - 65.7 mpg of fuel consumption and 98 g to 99 g of CO<sub>2</sub> emissions, certified values depending on version / according to WLTP data / UTAC source. For full hybrid E-Tech versions.

(4) for an full hybrid E-Tech engine compared to an internal combustion engine, according to WLTP City protocol / UTAC & IDIADA source.

[configure and order →](#)

## next-generation comfort

Take a seat in a contemporary interior featuring heated front seats<sup>(1)</sup>, made from biobased materials and a heated steering wheel stamped with the new Renault identity. Personalise the driving experience with the three multi-sense modes<sup>(1)</sup>.



Created from the partnership with Tencel™, the coatings of the upholstery, doors and dashboard contain 60% plant fibres<sup>(1)</sup>, with the wood used guaranteed to come exclusively from sustainably managed European forests. There is no leather in Clio: instead, the surfaces are covered in TEP, a grained coated fabric made of bio-sourced and polyester fibres.



techno+ version upholstery

(1) available on techno+ and esprit Alpine versions.

## more welcoming than ever

Thanks to its feel for comfort and roominess, the rear provides excellent knee room of 16.5 cm and optimal headroom to accommodate both children and adults.



Enjoy the generous boot volume of up to 391L<sup>(1)</sup>. Adjust the 1/3-2/3 bench seat very easily for available space of up to 1,069L in the configuration with three seats folded down.



<sup>(1)</sup> 301 L / 1,006L on E-Tech. 391 L / 1,069 L on TCe 90.

[configure and order →](#)

## resolutely connected

Renault Clio connects you to the remote services you need. Enjoy the easylink connected system and its 9.3" multimedia touch screen<sup>(1)</sup>, with on-board navigation and wireless smartphone replication.



The wireless replication compatible with Android Auto™ and Apple CarPlay™ shows all of your apps, playlists, podcasts and calls on the multimedia screen

The customisable 10"<sup>(2)</sup> digital driver display keeps essential driving information in your direct view.



Stay permanently connected thanks to the wireless induction charger<sup>(3)</sup>, located in the central storage space, to recharge your smartphone at any time without having to plug it in.



(1) 7" touch screen on generation and techno+, 9.3" on esprit Alpine versions.  
(2) 7" digital driver display on generation and techno+, 10" on esprit Alpine versions.  
(3) standard on techno+ and esprit Alpine trims.

Android Auto™ is a trademark of Google Inc.

Apple CarPlay™ is a trademark of Apple Inc.

[configure and order →](#)

## 05. advanced driver-assistance systems



# up to 22 advanced driver-assistance systems<sup>(1)</sup>

As part of the human first program, Renault Clio offers up to 22<sup>(1)</sup> advanced and innovative driver-assistance systems.

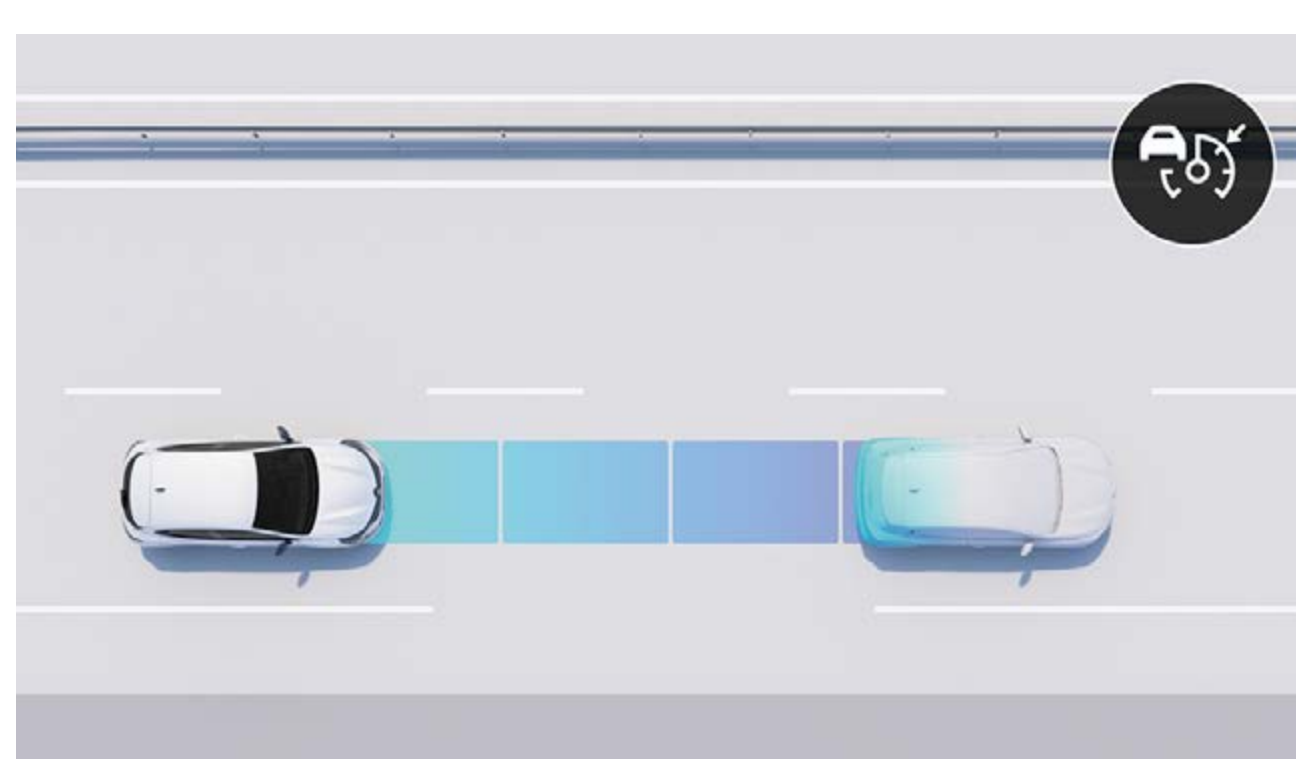

**adaptive cruise control<sup>(2)</sup>**  
The system keeps a safe following distance from the vehicle in front of you. It activates the brakes if you get too close, and accelerates when the road is clear again.

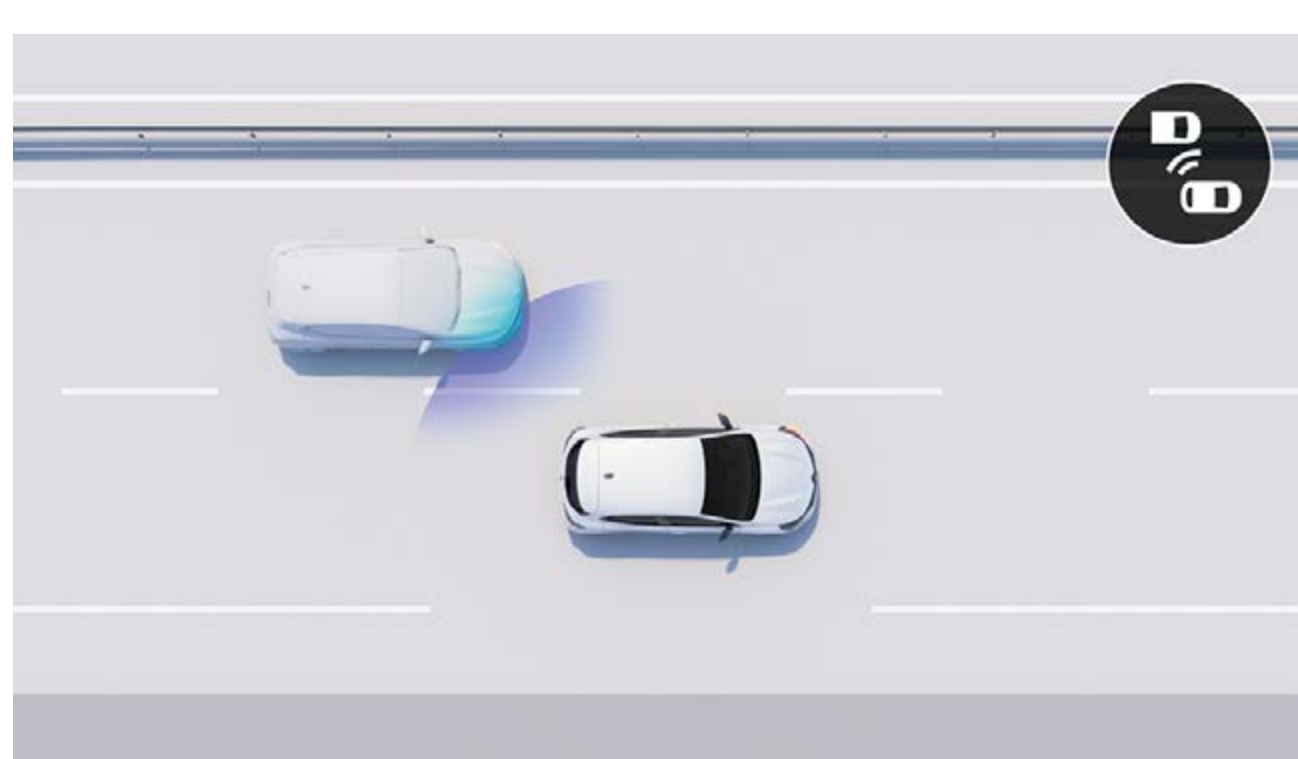

**blind spot warning<sup>(2)</sup>**  
Enabled at speeds over 9mph, this system uses warning lights on the door mirrors to alert you to the presence of vehicles that are not visible in your field of vision.

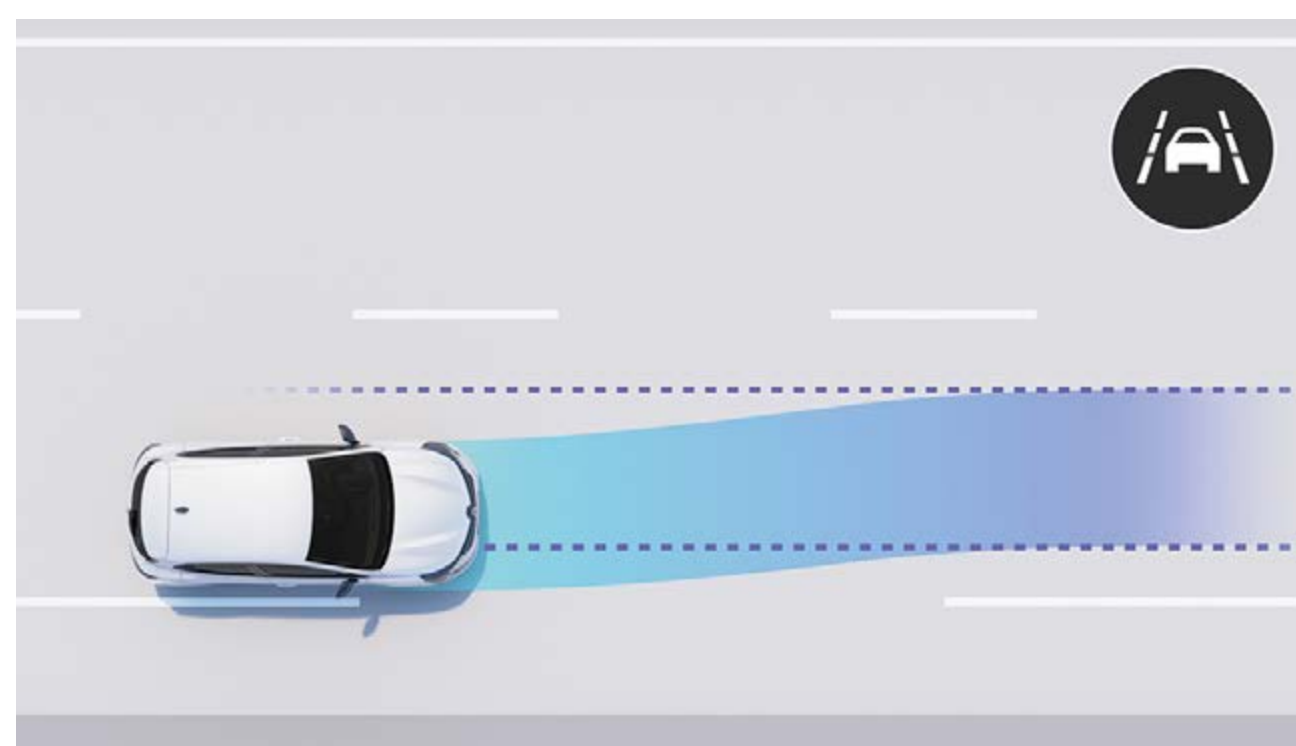

**lane keeping assist**  
This system corrects the angle of the steering wheel, returning the vehicle to its lane unless you have indicated.



**automatic emergency braking with emergency brake assist**  
Warns the driver of an imminent risk of frontal collision with a stationary vehicle, at low speeds. Triggers automatic emergency braking to avoid or mitigate a collision.



**rear view camera**  
This system provides a rear view on the screen when you engage the reverse gear. Superimposed outlines make your manoeuvres easier and safer.



**360 around view 3D camera<sup>(2)</sup>**  
The four cameras help recreate a 360 view of the vehicle's direct environment, allowing you to perform your parking manoeuvres effortlessly.



**rear cross traffic alert<sup>(2)</sup>**  
When reversing, the system warns you of a risk of collision with a vehicle.

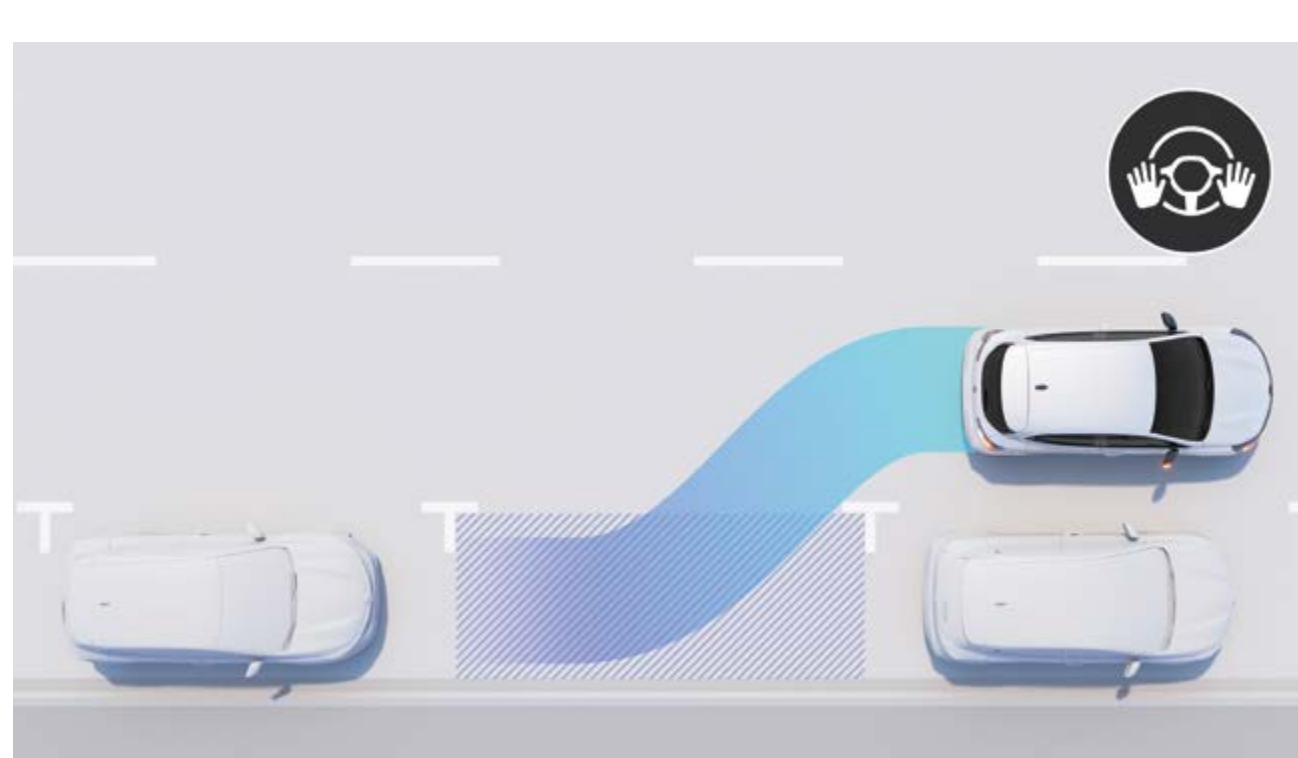

**hands free parking<sup>(2)</sup>**  
Using ultrasonic detectors, this function helps to find accessible parking spaces and assists in the parking manoeuvre. driver controls the accelerator pedal and brake pedal<sup>(2)</sup>.

### driver assistance

- hill start assist
- distance warning alert
- speed limiter
- cruise control
- adaptive cruise control<sup>(2)</sup>
- overspeed prevention

### parking assistance

- front parking sensors
- rear parking sensors
- side parking sensors<sup>(2)</sup>
- rear view camera
- 360 around view 3D camera<sup>(2)</sup>
- hands-free parking system<sup>(2)</sup>

### safety assistance

- lane departure warning
- lane keeping assist
- blind spot warning<sup>(2)</sup>
- rear cross traffic alert<sup>(2)</sup>
- auto lighting and rain sensor with auto wipers
- auto high/low beam/dipped headlights activation<sup>(3)</sup>
- automatic emergency braking with emergency brake assist
- road sign recognition and speeding alert
- active emergency braking with pedestrian and cyclist detection
- driver attention alert

(1) up to 22 adas features across the range, their responses are version dependant. Always follow road safety regulations. It is your responsibility to stay alert, drive safely and be in control of the vehicle at all times. You should not solely rely on driver convenience and assistance features. Some features may not work in all conditions and circumstances, and they have speed and other limitations.

(2) iconic esprit Alpine only.

(3) esprit Alpine only.

**configure and order →**

## 06. customisation

# colours



**glacier white (nmp)\***



**shadow grey (mp)**



**diamond black (mp)**



**iron blue (mp)**



**ceramic grey (mp) [stock only]**



**valencia orange (mp)**

nmp: non-metallic paint.  
mp: metallic paint.  
\* standard paint on all trims

**configure and order →**

## 06. customisation

# interior trims



### generation

- 7" touchscreen with easy link & navigation
- 7" digital driver display
- synthetic leather steering wheel
- generation grey fabric seats
- tinted rear windows and tailgate
- Arkamys six speaker audio system
- 2 front USB ports + 1 front AUX
- my safety switch: shortcut to personalise configuration of driving aids
- 3 MULTI-SENSE driving modes [eco, sport and my sense] including 8 ambient light settings



### techno+

- 60% biobased upholstery, textured coated black fabric
- wireless phone charger
- heated front seats



### techno esprit Alpine

- 10" digital driver display
- 9.3" touchscreen with easy link and navigation
- esprit Alpine enveloping fabric seats with sustainable fabric synthetic leather and Alpine detailing



### iconic esprit Alpine

- Bose 9-speaker premium audio system
- heated steering wheel



**download the interior trims and equipment PDF (6 MB)**

## 06. customisation

# upholstery

generation



grey fabric upholstery

techno+



black fabric upholstery

esprit Alpine trims



esprit Alpine enveloping fabric seats with sustainable fabric synthetic leather detailing

# hubcaps and wheel rims

generation



16" boa vista alloy wheel

techno+



17" monastella diamond cut alloy

esprit Alpine trims



17" esprit Alpine diamond cut alloy<sup>(1)</sup>

(1) blue centre caps on all colours except valencia orange.

[configure and order →](#)

## 06. customisation

# accessory packs

### style pack (generation only)



shark antenna



illuminated door sills



chrome mirror shells

### style pack (techno+ and esprit Alpine versions)



chrome mirror shells



underbody welcome light

### protection pack (generation only)



boot sill protector



reversible boot mat



illuminated door sills

### protection pack (techno+ and esprit Alpine versions)



boot sill protector



reversible boot mat

### touring pack



quickfix roof bars



roof box 380L

### cycle pack



quickfix roof bars



2 x roof mounted bicycle carriers

### dash cam pack



Front and rear dashcam

### storage pack



boot storage box

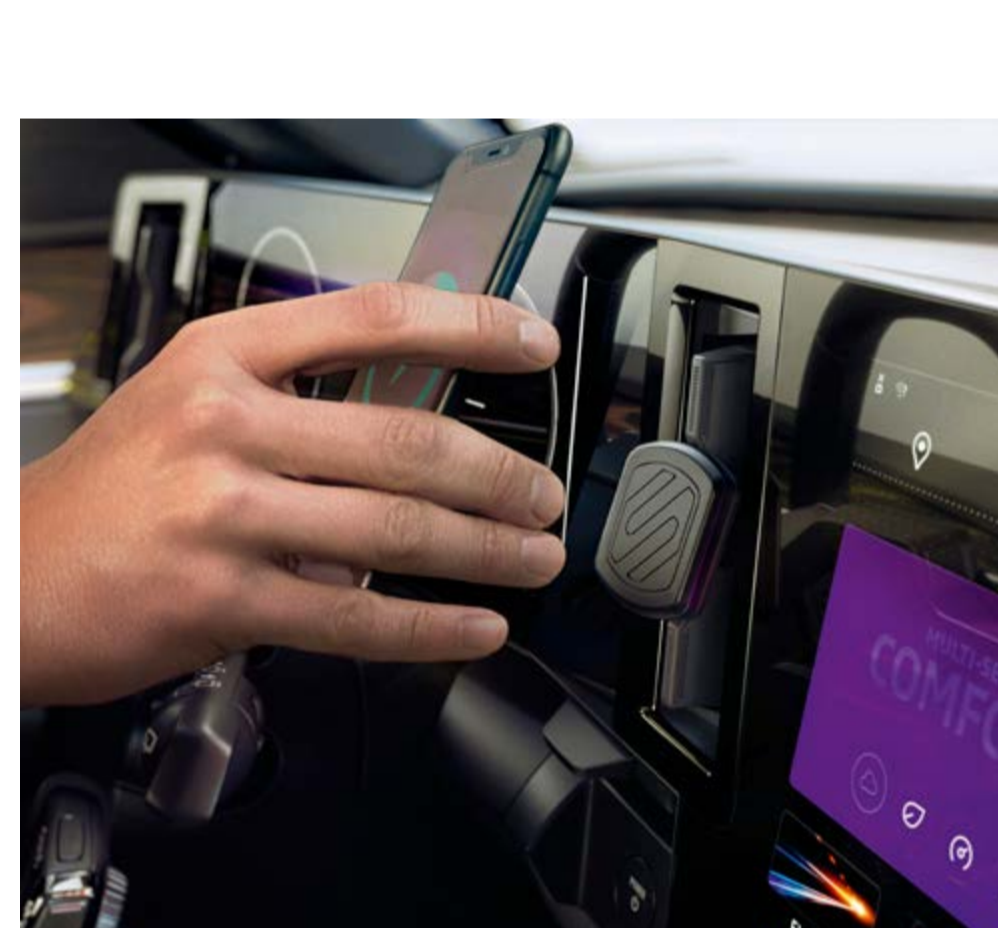

magnetic smartphone holder

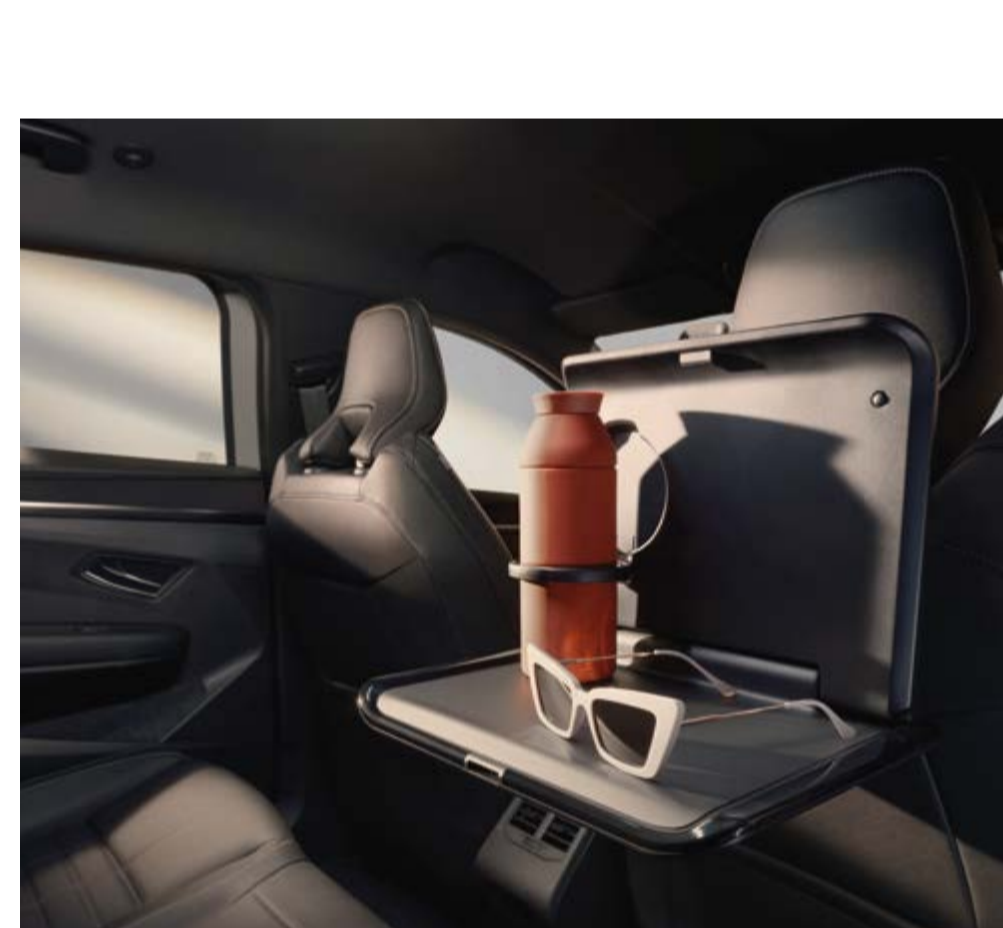

rear tray table & fixing

storage pack + available with 2 tray tables & 2 fixings

### towbar packs



swan neck towbar 13 pin  
removable towbar 13 pin

### premium delivery packs



premium floor mats



reversible boot mat



safety kit

key card wallet

### premium delivery pack

### premium delivery pack +

premium delivery packs also available with Esprit Alpine textile floor mats



esprit alpine textile floor mats

All accessories purchased prior to vehicle registration come with a 3 year manufacturers warranty. Accessories are fitted post production and may have an impact on WLTP fuel (actual) consumption and CO<sub>2</sub> figures

 **download the accessories brochure PDF (6 MB)**

**configure and order →**

## 06. customisation

# engines

full hybrid E-Tech 145		TCe 90
<b>fuel</b>		
unleaded petrol (E10) + full hybrid		unleaded petrol (E10)
<b>maximum power (hp)/revs (rpm)</b>		
145/5,600		90/5000
<b>maximum torque (Nm)/revs (rpm) engine and e-motor</b>		
144/3,200-3,600	205	160/3,750
<b>battery (kWh)</b>		<b>gearbox</b>
1.2		6-speed manual
<b>kerb weight (kg)</b>		
1,238		1,082



**download the  
engines PDF (6MB)**

# dimensions and volumes

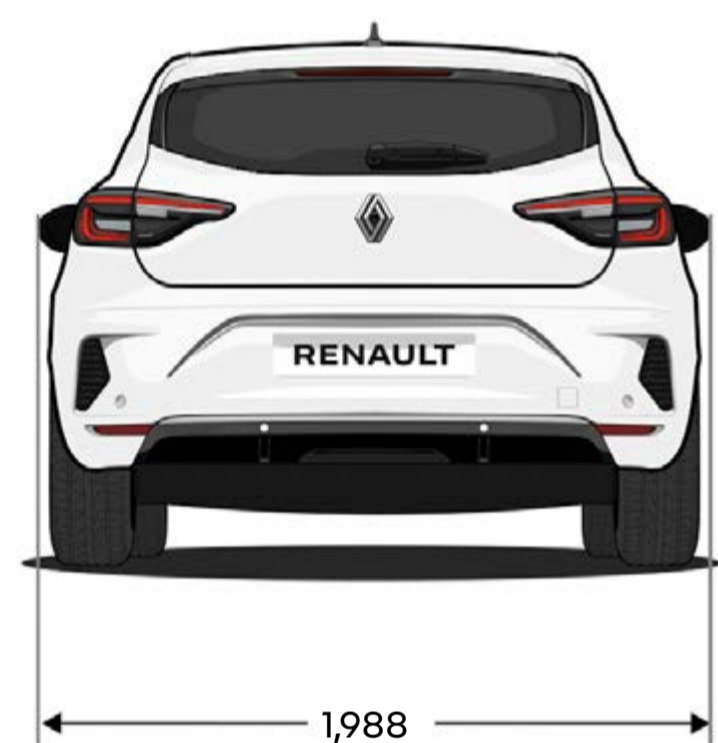
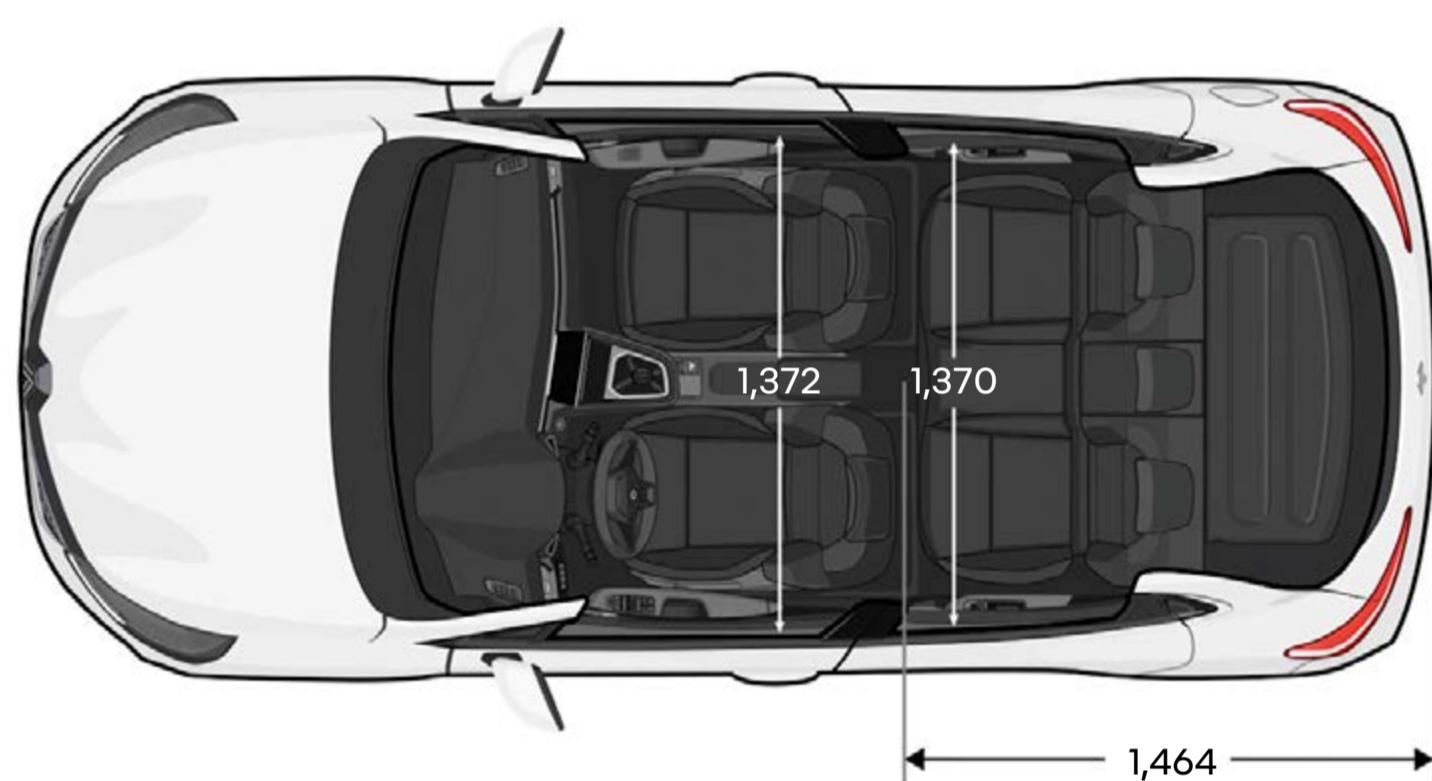
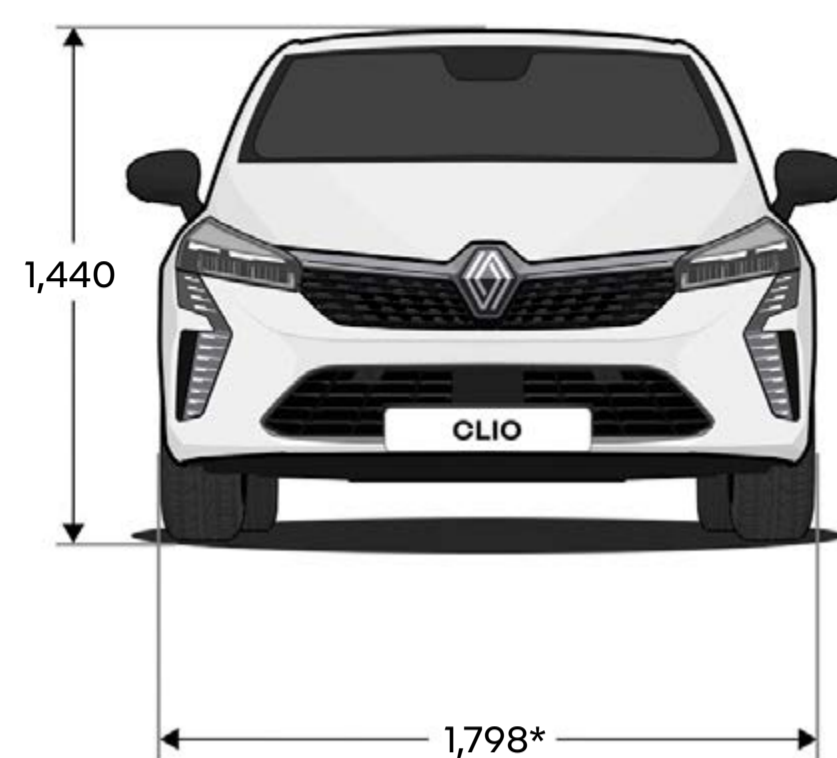
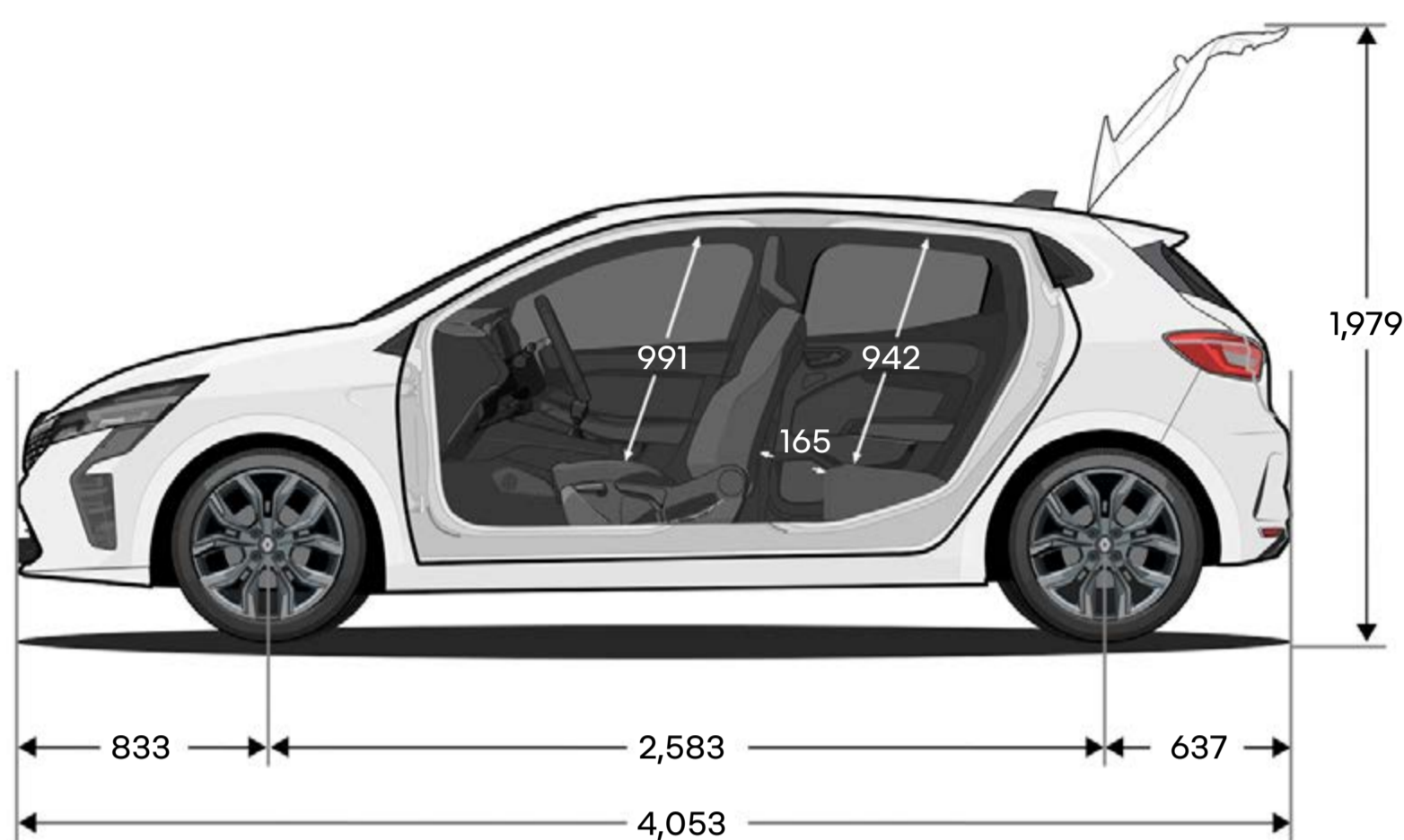

## boot volume (litres)

## full hybrid E-Tech

## TCe 90

max with tyre inflation kit

301

391

max bench seat folded down with tyre inflation kit

1,006

1,069

\* door mirrors folded.  
dimensions in (mm).

[configure and order →](#)

# Renault care service

**We are always by your side to make your driving experience easier and save you time with the maintenance of your Renault: online quotes and appointments, fixed price packages, maintenance contracts, insurance and assistance, personalised My Renault programme, etc. Take advantage of our simple and fast solutions tailored to your needs.**

**[find out more about Renault care service](#)**



Every precaution has been taken to ensure that the contents of this brochure were accurate and up-to-date at the time of its release. This document has been created using pre-production and prototype models. In line with its policy of continuous product improvement, Renault reserves the right to modify the specifications, vehicles and accessories described and featured at any time. Any such modifications are communicated to Renault dealers as quickly as possible. Depending on the country of sale, versions may differ and some equipment may be unavailable (standard, optional or accessories). Please contact your local dealer for the latest information. For reasons to do with the medium, the colours featured in this document may differ slightly from those of the actual paintwork or interior trim. All rights reserved. Reproduction in any format and by any means of all or part of this brochure is prohibited without prior written authorisation from Renault.

Publicis - photo credits: M. Leuvrey, ©Renault Marketing 3D-Commerce - April 2026.

Renault recommends



**configure and order →**