

**NEW**  
**RENAULT MASTER &**  
**MASTER E-TECH**  
100 % electric



1 April 2025



# aerovan generation

**Designed in a wind tunnel and completely reshaped, the new Renault Master is ushering in a new era for commercial vehicles by becoming the aerovan. Aerodynamics and technologies for efficiency, connectivity with Google<sup>(1)</sup> built in, assisted driving and great user comfort.**



**available with E-Tech 100% electric and diesel engines, the new Renault Master helps you meet all your professional challenges.**

**wide range of converted vehicles through our approved suppliers**

**up to 1,500 kg of payload<sup>(2)</sup>**

**up to 285 miles of driving range<sup>(2)(3)</sup> with 100% electric E-Tech**

**openR link multimedia system with Google built-in<sup>(1)</sup>**

**dynamic braking system**

**20 advanced driver-assistance systems**

(1) Available as an option on Advance versions, standard on Extra versions. My Renault, Google Maps and Google Assistant connected services are provided free of charge for 5 years from the date of delivery of your vehicle. Google, Google Maps, Google News, Waze and other brand names are all trademarks of Google LLC. (2) in L2H2 E-Tech 100% electric version – 87 kWh – 4 tonnes. (3) measurement at the socket in the WLTP cycle.



# **interactive menu**

**01. design**

**02. interior experience**

**03. loading**

**04. multimedia**

**05. engines**

**06. range and charging**

**07. converted versions**

**08. advanced driving  
assistance systems**

**09. customisation**

**PDF for download**

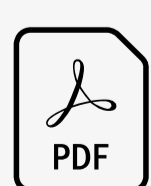

**equipment and engines**



**accessories**

# high-performance design

The tilt of the windscreen, the air intakes, the shape of the wing mirrors and the streamlined design of the rear area: all the key design elements have been optimised to enhance the vehicle's aerodynamic performance.



Drawing inspiration from American trucks, the robust styling of the grille incorporating the new Renault emblem gives it a powerful personality.



[build yours →](#)

[menu](#)



## a driver oriented cockpit

The interior combines an innovative driving position with a high level of working comfort: wrap-around individual seats, driver-oriented S-shaped dashboard for easy-to-access controls.



Enjoy workspace focused on your needs: mobile office with connectivity, USB-C\* and 12V sockets, reinforced upholstery covering for optimised durability.



With nine storage areas with a total capacity of 135L, the new Renault Master is among the market's leading vehicles that will enable you to stay optimally organised.



66-litre storage compartment under front passenger seats

\*optional

[build yours →](#)



## 03. loading

# optimal loading

**Best-in-class loading performance:  
up to 1,500kg<sup>(1)(2)</sup> of payload and  
2.5 tonnes of towing capacity.**



**And also the best sliding side  
opening in its category with  
1,312mm<sup>(2)</sup>, rear doors that open  
at 270°<sup>(3)</sup> and the foot step<sup>(3)</sup>  
of the new Renault Master provide  
easy access to the loading area.**



(1) on the L2H2 E-Tech 100% electric version – 87 kWh – 4 tonnes. (2) van version, Large Van category. Renault study of 27/10/2023. (3) 270 degree opening doors and rear step available as an optional.

[build yours →](#)

[menu](#)



# openR link multimedia system with Google built-in<sup>(1)</sup>

Enjoy a 10" screen equipped with the openR link multimedia system and the Google built-in option<sup>(1)</sup>. A fluid and intuitive interface that supports you on all your business trips.



Access all the Google tools and services you need. With Google Maps<sup>(1)</sup>, get numerous features: continuous updates, real-time traffic, information about points of interest, etc.



Using Google Assistant<sup>(1)</sup>, manage your journeys, your communications or the temperature on board by voice control, without compromising your driving experience.



Choose from more than 50 apps: manage your parking with EasyPark, listen to music with Amazon Music or check your emails with the Vivaldi browser.



Waze is a community-based navigation app that shares information in real time. Waze boosts your peace of mind.



Take to the road while listening to playlists, and much more, with Amazon Music, included with your Amazon Prime subscription.



Vivaldi browser is an efficient, fast web browser that respects your privacy.



With EasyPark, plan and book millions of parking spaces across Europe. Enter your destination's address or navigate using the map.

<sup>(1)</sup> standard on Extra trim level and option on Advance. My Renault, Google Maps and Google Assistant connected services are provided free of charge for 5 years from the date of delivery of your vehicle. Google, Google Maps, Google News, Waze and other marks are trademarks of Google LLC.



# applications for professionals

In partnership with specialists, New Renault Master offers a customised solution for professionals thanks to the openR link with convertor companion<sup>(1)</sup> option, which allows you to manage the specific features of your converted vehicle directly from the 10" screen.



## TIB application

Designed for fire brigade vehicles, it can be used, for example, to control the exterior and interior lighting, or open and close the doors; it can also provide battery status.

## Lamberet application

Designed for refrigerated vehicles, it is used for temperature management, and can let you know if they are registered.

## Modul System application

For workshop vehicles, it automatically calculates loading (among other things) and lets you know if you are overloading your vehicle.

(1) optional.



# My Renault connected services

**With the My Renault application, manage your vehicle remotely easily via your smartphone: unlocking alert, vehicle location, remote activation of the lights and horn.**



## Make everyday life easier with the My Renault application

### organise your journeys

- plan your journey, automatically adding stops at petrol stations / charging stations
- locate your vehicle at any time
- find your vehicle by activating the horn and lights

### control your E-Tech 100% electric version

- check in real time the level of charge and driving range of your battery
- Remotely programme and manage your charging and cabin temperature
- locate the public charging points nearest to you

### view your vehicle's finer details

- discover all the features of your vehicle thanks to our video tutorials and vehicle instructions
- find your service contracts and warranty extensions
- access our store to find services and accessories for your vehicle

### manage your vehicle's maintenance

- access your maintenance history and receive alerts for upcoming services
- make an appointment in the workshop
- benefit from customised Renault offers

**build yours →**



## at the forefront of innovation

**New Master offers a range of diesel and E-Tech 100% electric engines: 3 Blue dCi powers and an electric battery to meet the needs of business customers.**



**Drive more than 620 miles<sup>(1)</sup> with the new innovative Blue dCi engine with reduced CO<sub>2</sub> emissions and lower fuel consumption<sup>(2)</sup>. This diesel version is also available with the all-new 9-speed automatic gearbox.**



**The New Renault Master offers a comfortable and safe braking experience: identical efficiency regardless of the loading weight and reaction time reduced by half during emergency braking<sup>(3)</sup>. In electric vehicles, the regenerative power of the new system and its reduced weight help extend your range.**



(1) Blue dCi 2L, combined cycle WLTP standard. (2) when comparing New Renault Master to previous versions of Renault Master. (3) if triggered by a driver assistance system.

**build yours →**



## 06. range and charging

# up to 285 miles of range<sup>(1)(2)</sup>

**With no CO<sub>2</sub> emissions, the 100% electric E-Tech version helps you during your daily urban trips and ensures you can access low-emission zones.**



**The progress achieved by optimising aerodynamics and the all-new platform combined with the dynamic braking system reduce electric consumption by 27%<sup>(3)</sup>.**

**The 87kWh battery provides a range of up to 285 miles and comes with 22kw AC and 130 DC charging as standard.**

### **aerodynamic design**

The new lines of the Renault Master E-Tech 100% electric have been designed to maximise its driving range: tilted windscreen, air intakes, the shape of the door mirrors and the streamlined rear section.

### **dynamic braking system**

This all-new compact system delivers the same braking efficiency regardless of the load weight and reduces reaction time in emergency braking by half. Each deceleration recovers energy and improves the overall range of the vehicle on 100% electric E-Tech versions.

### **low-consumption tyres**

Their low rolling resistance helps to preserve driving range without adversely affecting road holding or braking quality.

### **range**

**87 kWh battery:**  
· up to 285 miles<sup>(1)(2)</sup> of range

(1) on the L2H2 E-Tech 100% electric version – 87 kWh – 4 tonnes. (2) measurement at the socket in the WLTP cycle. (3) measurement at the socket in the WLTP cycle compared New Renault Master L2H2 E-Tech 100% electric 87 kWh versus Renault Master E-Tech 100% electric 52 kWh. Internal Renault study (4) Approval in progress.



## 06. range and charging

# easy to charge

**At home, at work or on the move, new Renault Master E-Tech 100% electric offers you a versatile range of charging solutions.**



## on-street charging

### **DC rapid charge<sup>(1)</sup> 130 kW maximum**

For longer journeys, get up to 285 miles<sup>(2)(3)</sup> of WLTP range in 1 h 10 from a DC rapid charging station.

### **My Renault application**

Locate and check the availability of public charging stations. Pay for your charging using the built-in Charge pass<sup>(4)</sup>.

### **Mobilize business pass**

With the Mobilize business pass designed for business use, recharge your fleet vehicles at Mobilize Power Solutions charging stations at work, at home and on the public grid.

## charging at work, at home or elsewhere

### **AC charging<sup>(5)</sup> 22 kW as standard**

Charge your new Renault Master E-Tech 100% electric on the domestic network with a wall-mounted charging point, a reinforced socket, or, for occasional charging, a standard domestic socket.



### **Mobilize power solutions**

Take advantage of a range of terminals and sockets best adapted to your needs and get support installing and using them.

(1) direct current. (2) on the L2H2 E-Tech 100% electric version - 87 kWh - 4 tonnes. (3) measurement at the socket in the WLTP cycle. (4) subject to subscribing to the service. (5) alternating current.

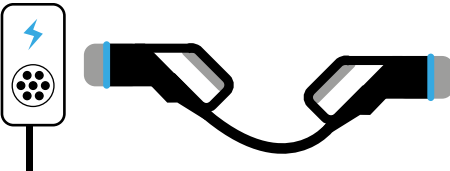
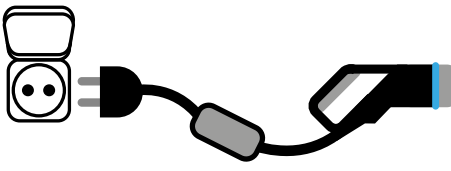
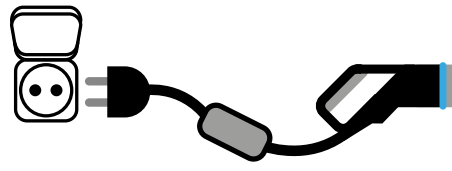

# New Renault Master E-Tech 100% electric is delivered with a mode 3-type cable that can be used with a domestic<sup>(1)</sup> or public charging station.

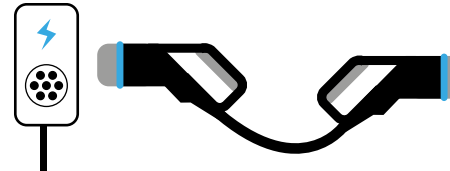
domestic			public	
<b>domestic charging station<sup>(1)</sup></b> 7.4 kW	<b>reinforced domestic socket</b> 3.7 kW	<b>standard domestic socket<sup>(2)</sup></b> 2.3 kW	<b>public fast charging point</b> 150 kW	<b>public charging station</b> 22 kW
mode 3 cable included with purchase	standard mode 2 or optional flexi-charger cable	optional mode 2 flexi-charger cable	cable attached to station	mode 3 cable included with purchase
				

## 87kWh battery<sup>(3)</sup> for a maximum range of 285 miles<sup>(5)(6)</sup>

31 miles → 1 h 55	31 miles → 3 h 55	31 miles → 6 h 28	31 miles → 6 min	31 miles → 38 min
112 miles → 5 h 44	112 miles → 11 h 46	112 miles → 21 h 59	112 miles → 19 min	112 miles → 1 h 53
286 miles → 13 h 54	286 miles → 28 h 30	286 miles → 47 h 02	286 miles → 1 h 10	286 miles → 4 h 35

For more information on Mobilize power solutions offering please visit [business.renault.co.uk/master-range/renault-master/recharge](https://business.renault.co.uk/master-range/renault-master/recharge) (2) only for occasional use. (3) connected to a 150kW public fast charging station. The charging times shown are calculated under optimal conditions for the battery, temperature values and charging stations. These times vary depending on the versions, options and programming of the vehicle. The distances are measurements based on the WLTP protocol. (4) approval in progress. (5) on the L2H2 E-Tech 100% electric version – 87 kWh – 4 tonnes. (6) measurement at the socket in the WLTP cycle.

**build yours →**



## your tailor-made utility vehicle

Renault provides a range of converted products through our industrial conversion facility at the Batilly plant and via our approved network of local converters partners.



crew van coming late 2024.

From crew vans to box vans to transport goods and people, to dropsides and tippers for construction, platform and chassis cabs for conversion, there is a new Renault Master for every activity sector.



double-cab chassis versions

Renault works with over 40 certified converters in the UK who can deliver everything from refrigerated vans to horseboxes.



single cab tipper version

[build yours →](#)



## 08. advanced driving assistance systems



# 20 advanced driver-assistance systems

As part of the human first program, Renault Master comes with 20 advanced-technology systems to ensure your safety and that of your passengers.

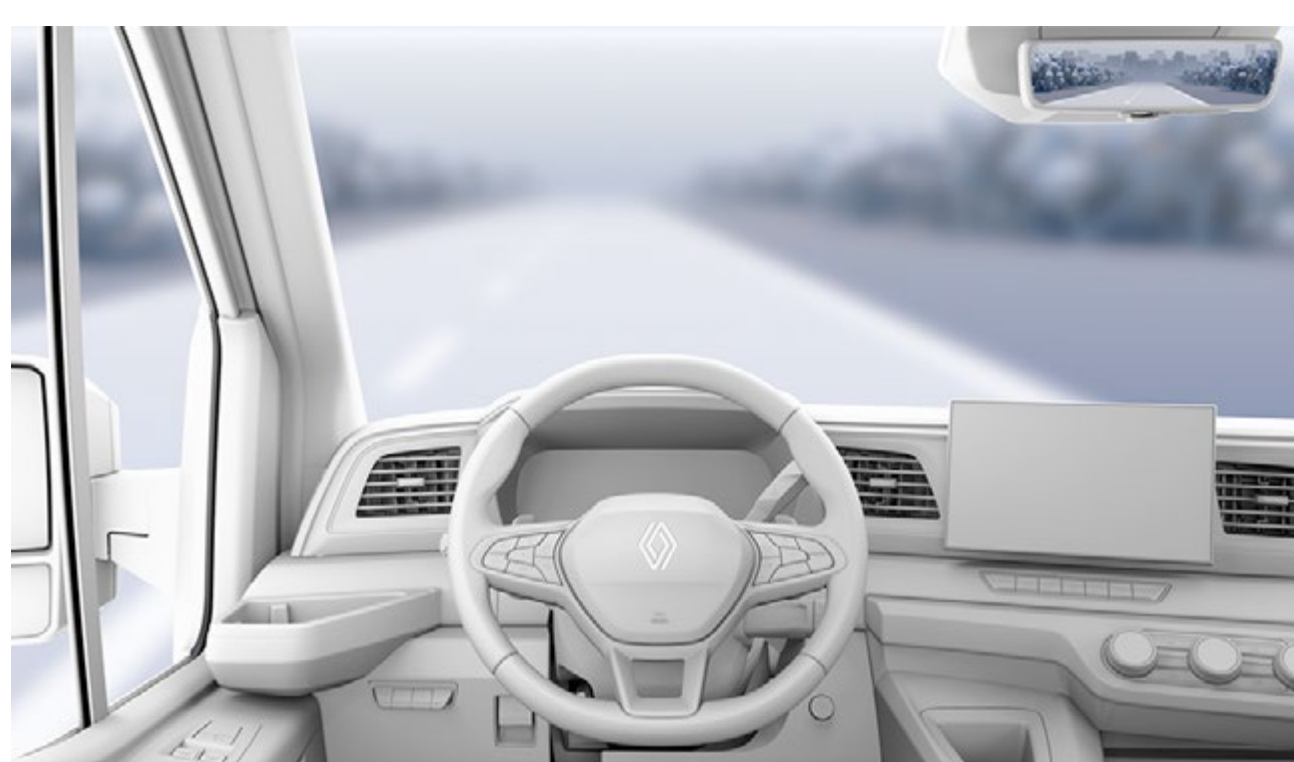

### rear view camera

Via a digital screen – instead of the interior rear-view mirror – you can view what the camera installed at the rear of your vehicle captures\*.

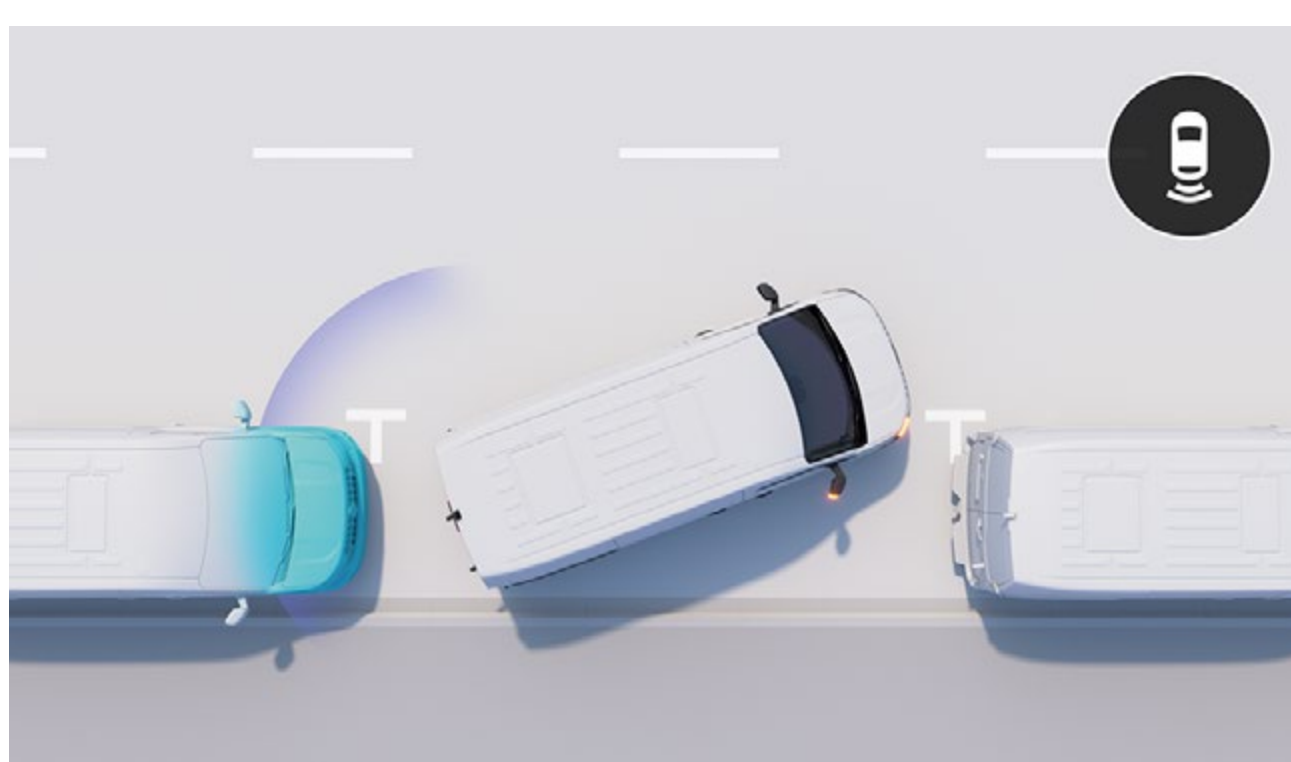

### rear parking sensors

Radar sensors facilitate your manoeuvres by warning you with audio and visual signals of the proximity of obstacles in front of or behind the vehicle.

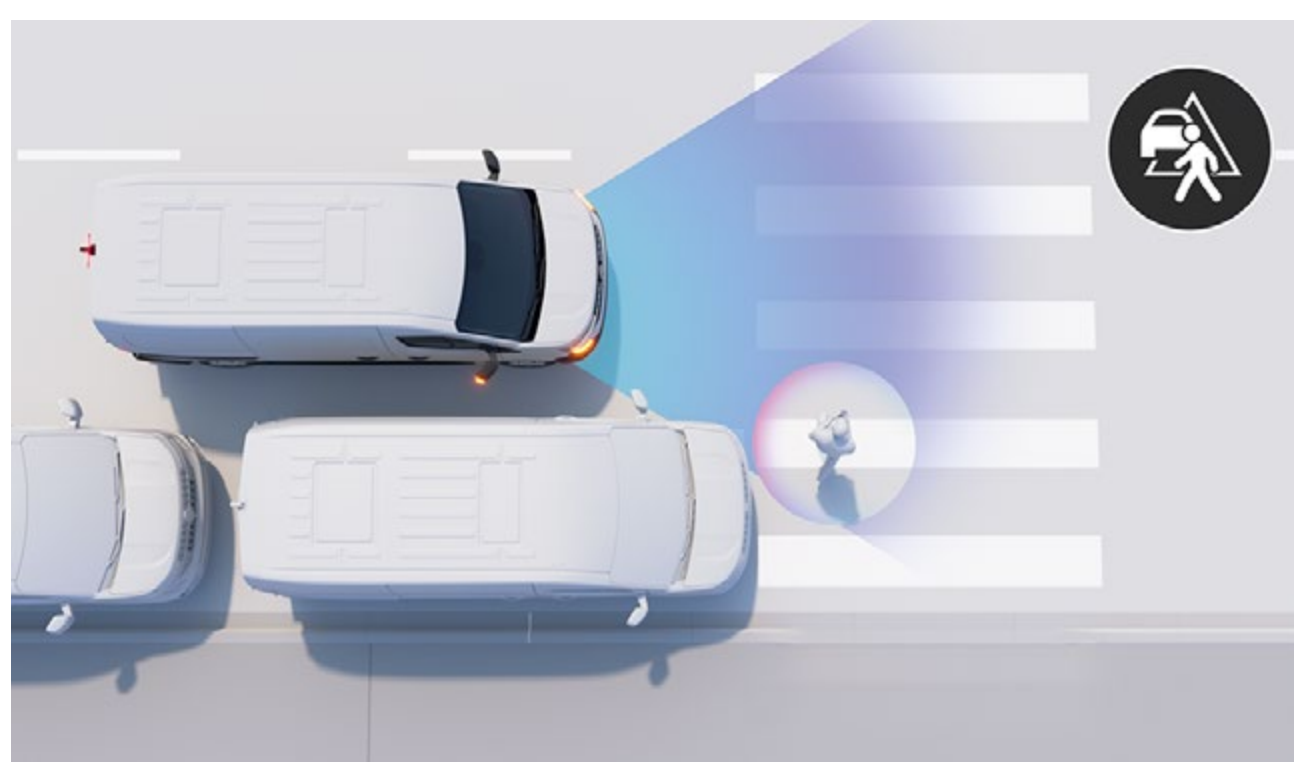

### automatic emergency braking with pedestrian/cyclist detection

Using a sensor, it detects pedestrians and cyclists coming from ahead or from the side, and prompts the driver to brake if there is a risk of collision. The system brakes harder if it detects that the driver has reacted too slowly, and can bring the vehicle to a complete stop if necessary\*\*.

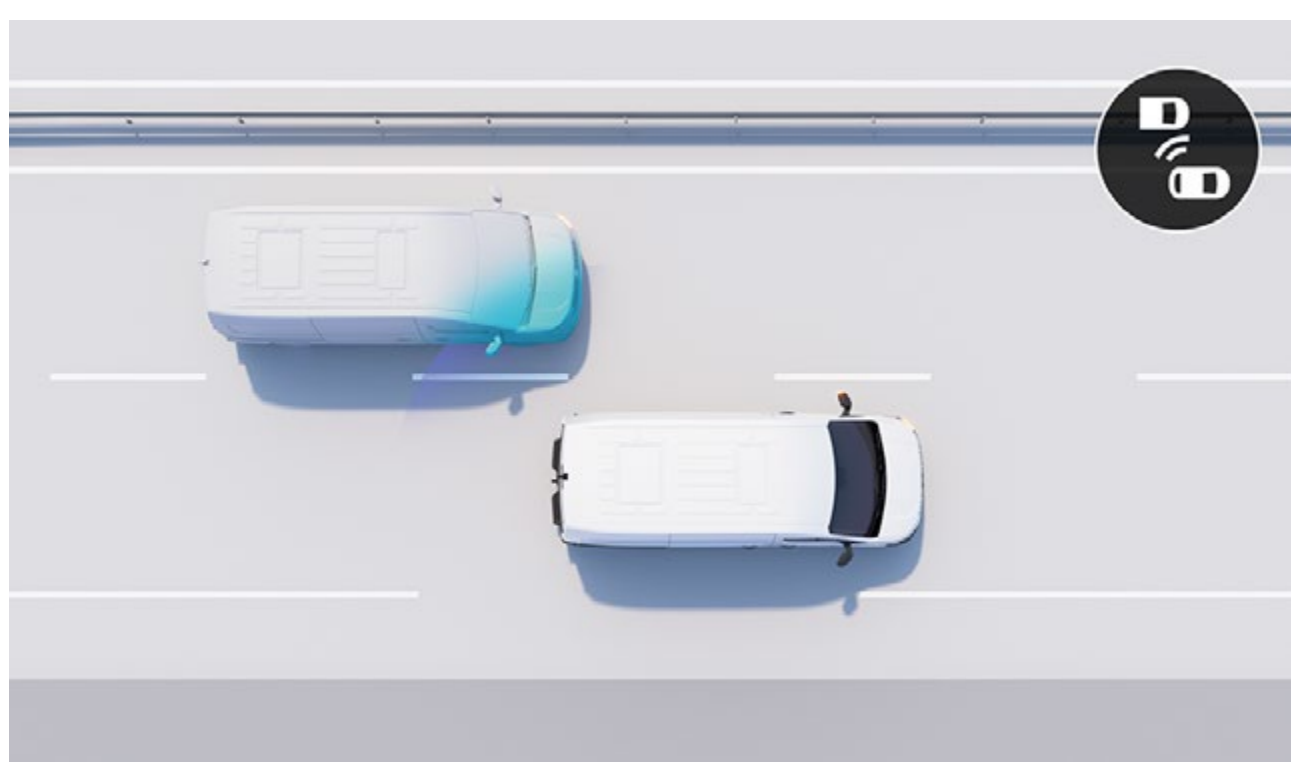

### blind spot warning

It can detect the presence of a cyclist or a vehicle in the rear side areas outside the field of visibility. A warning light in the door mirrors alerts the driver. On the passenger side, a radar detects cyclists in the blind spot on the passenger side and triggers an audible light signal\*.

### driving assistance systems

- rear view assist\*
- automatic main/dipped beam headlight activation\*
- road sign recognition and speeding alert

### park assist systems

- front parking sensors\*
- rear parking sensors
- side parking sensors\*
- rear view camera\*

### safety assistance systems

- anti-lock braking system
- blind spot warning\*
- automatic emergency braking
- automatic emergency braking with pedestrian/cyclist detection

\*optional. \*\* Pedestrian/cyclist on MM40 and LM40 only.

[build yours →](#)



## 09. customisation

# colours



agave blue<sup>(1)\*</sup>



tempest<sup>(2)</sup>



star grey<sup>(2)</sup>



pearl black<sup>(2)</sup>



mineral white<sup>(1)</sup>



urban grey<sup>(1)</sup>



energy red<sup>(1)\*</sup>

(1) solid non-metallic.

(2) metallic.

\*Please note agave blue and energy red are priced as metallic paints.

**build yours →**



## 09. customisation

# interior trims



### advance

- 3.5" black and white TFT display
- 7" colour TFT driver information display (E-Tech only)
- front LED lights with C-shaped signature
- dynamic braking system
- automatic headlights and wipers
- 10" openR link multimedia system
- 12 V socket in central console
- manual air conditioning
- dark marl fabric upholstery with dark grey stitching



### extra (advance+)

- 16" steel wheel rims with large wheel covers
- 10" openR link multimedia system with Google built-in<sup>(1)</sup>
- grey marl fabric upholstery with blue stitching

(1) available as an option, depending on the version. My Renault, Google Maps and Google Assistant connected services are provided free of charge for 5 years from the date of delivery of your vehicle. Google, Google Maps, Google News, Waze and other brand names are all trademarks of Google LLC.



**download details of interior trims  
and equipment in PDF format (6 MB)**



## 09. customisation

# upholstery



**dark grey marled fabric upholstery and reinforced driver seat side in grained coated textile<sup>(1)</sup>**



**grey marled fabric upholstery with blue top-stitching and reinforced driver seat side in grained coated textile<sup>(2)</sup>**

# hubcaps and wheel rims



**16" steel wheel rim extended vango protection<sup>(1)</sup>**



**16" steel wheel rims airna hubcap**

(1) standard on advance. (2) standard on extra and E-Tech 100% electric versions.

**build yours →**



## 06. customisation

# accessories

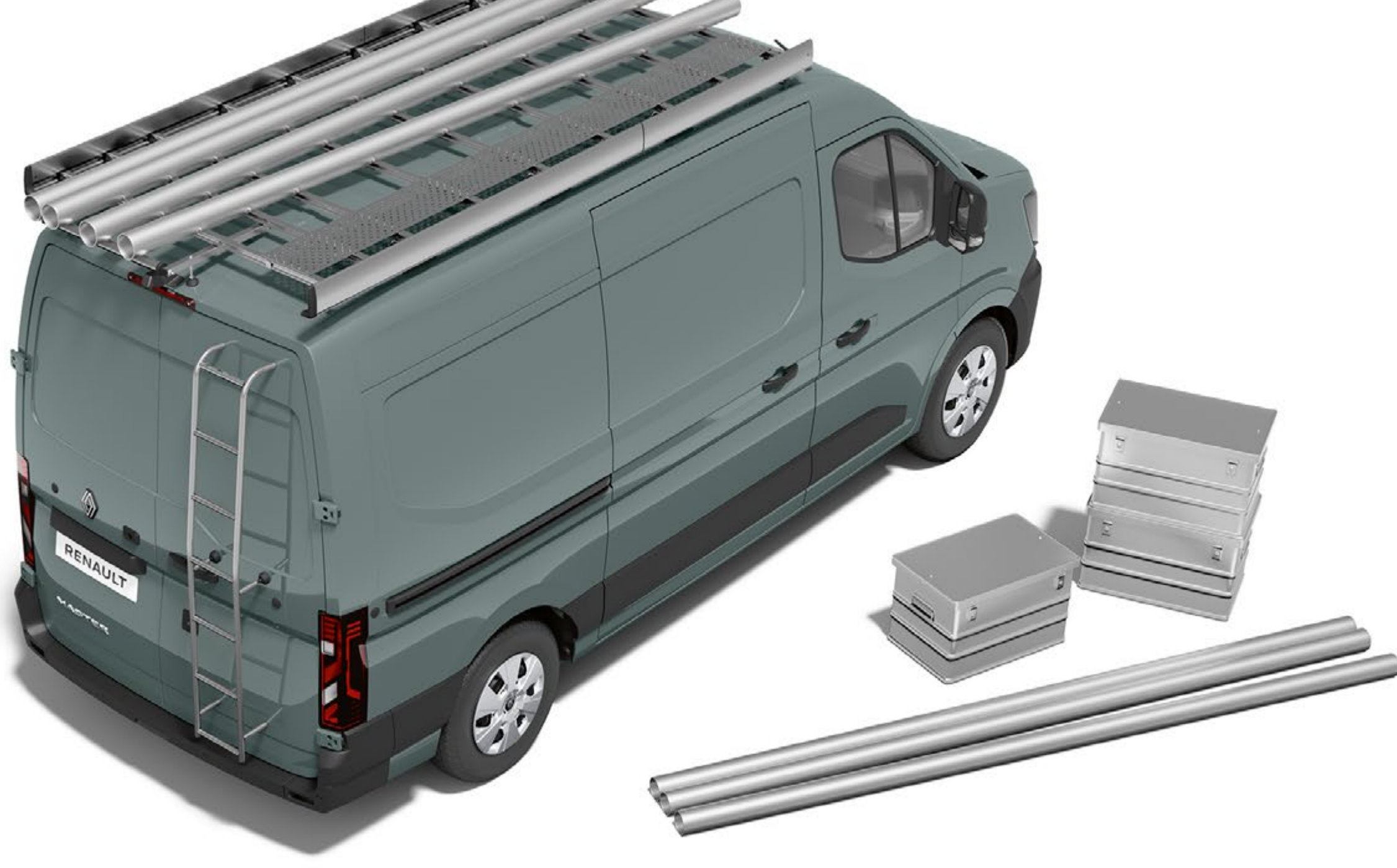

### roof rack, walkway and a ladder

Equip your new Renault Master with the aluminium roof rack that can carry up to 150 kg of additional load. Used in conjunction with a walkway and ladder, it is everything you need for transporting bulky equipment safely.



### roof bars

Ideal for increasing the vehicle's loading capacity. This official Renault accessory meets requirements well above safety and resistance standards.



### standard towbar with ball joint

Easy to attach, use it to safely tow trailers and professional equipment. Perfectly compatible with the vehicle, it will not damage the body in any way. Intended for intensive use and a multiplicity of uses.



### front and rear mud guards

Effectively protect the sill panel against mud splashes and grit.



### textile floor mats

Provide complete protection of the passenger compartment floor. Custom-fitted and specially designed for the vehicle, they can be easily fastened to two secure clips and do not interfere with the pedals. Easy to maintain.



### rubber floor mats - coming soon

Protect your cabin floor with these heavy-duty floor mats. Waterproof and easy to maintain, they can be quickly attached using the special safety clips provided.

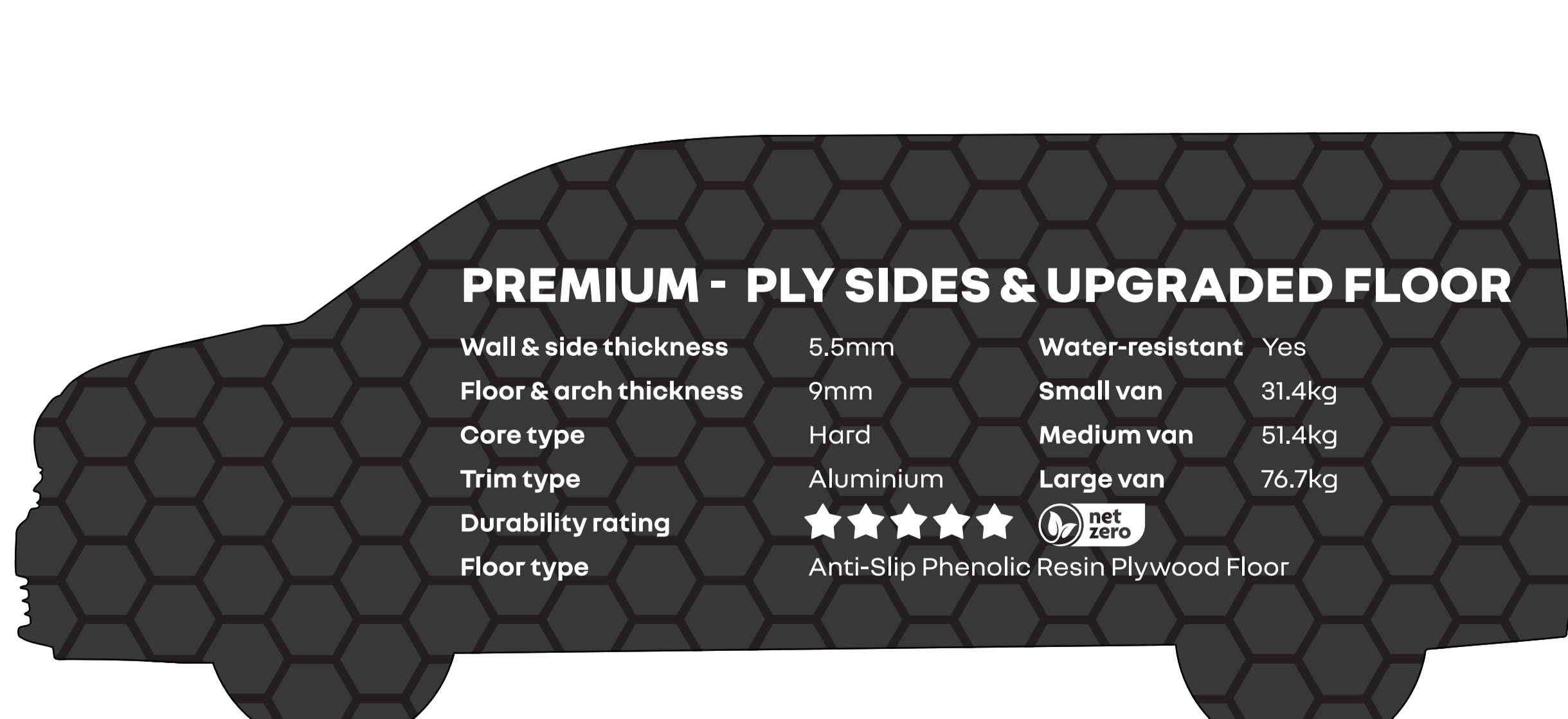

### ply lining

Choose our Ply Lining to increase the practicality of your new Van. Available in Standard, Premium + Bubblecore. For fitment at our Import Centre.



**download the accessories brochure in PDF format (6 MB)**

**build yours →**



## 09. customisation

# E-Tech engines

<b>100% electric</b>	
<b>max. power kW EEC (hp)</b>	
105(140)	
<b>max. torque EEC-Nm</b>	
300	
<b>battery</b>	
<b>storage capacity (kWh)</b>	
87	
<b>WLTP range (km)<sup>(1)</sup></b>	
255 miles (N1) 285 miles (N2) <sup>(3)</sup>	
<b>type of charger</b>	
22 kW AC with DC 130	
<b>performance</b>	
<b>top speed (mph)</b>	
75 mph (120 km/h)	
<b>certification protocol</b>	
WLTP <sup>(1)</sup>	

(1) WLTP (Worldwide Harmonised Light Vehicle Test Procedures): this new protocol provides results much closer to those found in daily use compared with the NEDC protocol.

(2) approval in progress.

(3) on the L2H2 E-Tech 100% electric version – 87 kWh – 4 tonnes. According to WLTP combined cycle standard.

# internal combustion engines

<b>Euro 6<sup>e</sup></b>			
Blue dCi 130	Blue dCi 150	Blue dCi 150 automatic gear box	Blue dCi 170 automatic gear box
<b>gearbox</b>			
6-speed manual gearbox	6-speed manual gearbox	automatic/9-speed <sup>(1)</sup>	automatic/9-speed <sup>(1)</sup>
<b>peak power kW EEC (hp) at rpm</b>			
96 (130) at 3 500	110 (150) at 3,500	110 (150) at 3,500	125 (170) at 3500
<b>peak torque Nm EEC at rpm</b>			
350 at 1,500	360 at 1,500	360 at 1,500	380 at 1,500
<b>bodywork type</b>			
<b>all types of bodywork</b>			
yes			
<b>panel vans, chassis cabs, platform cabs, dropsides, tippers, luton low loaders and luton box vans</b>			
yes			

(1) coming soon.

 **download the PDF (6MB)  
of the engines**



# dimensions, volumes and weights

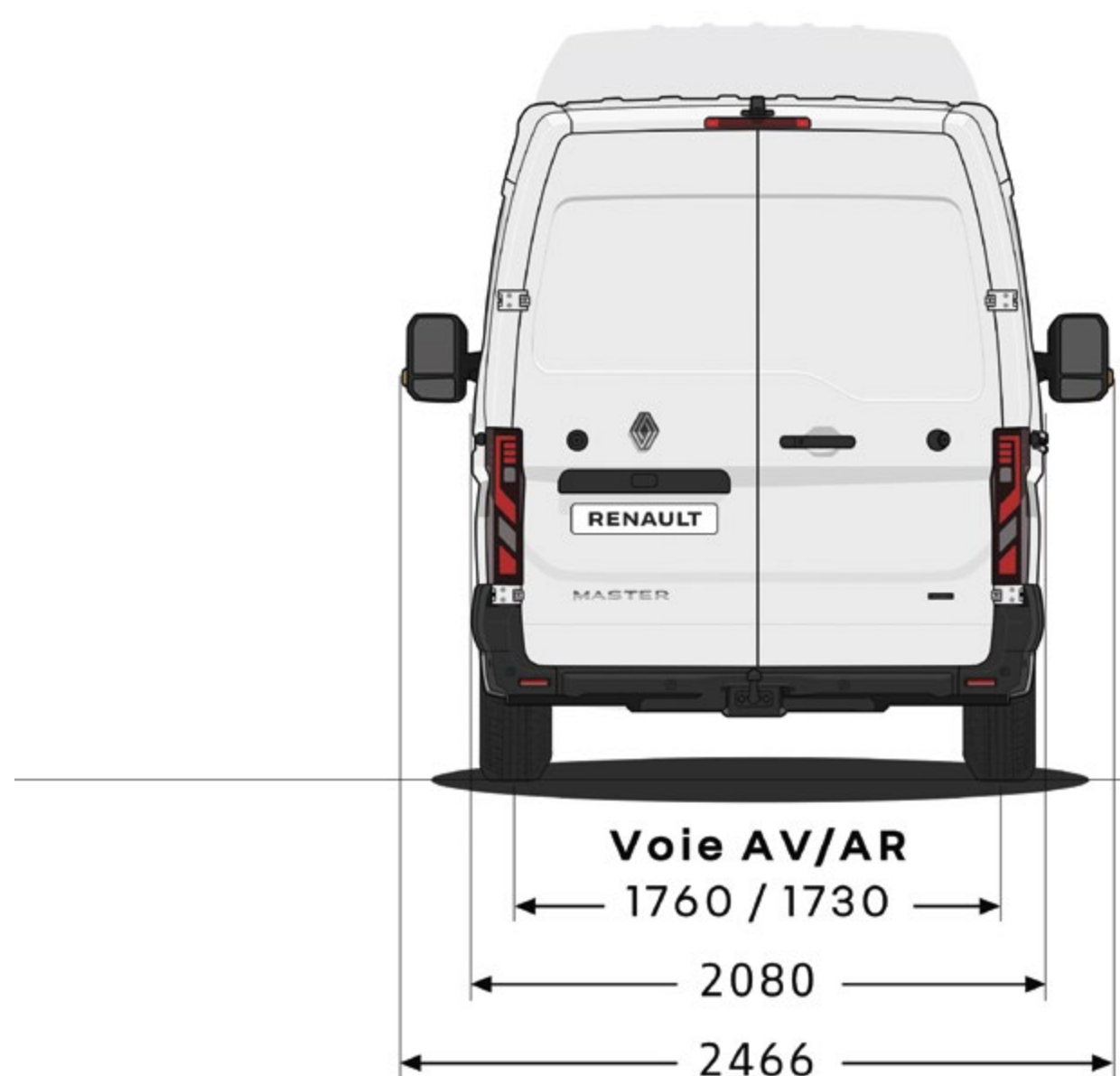
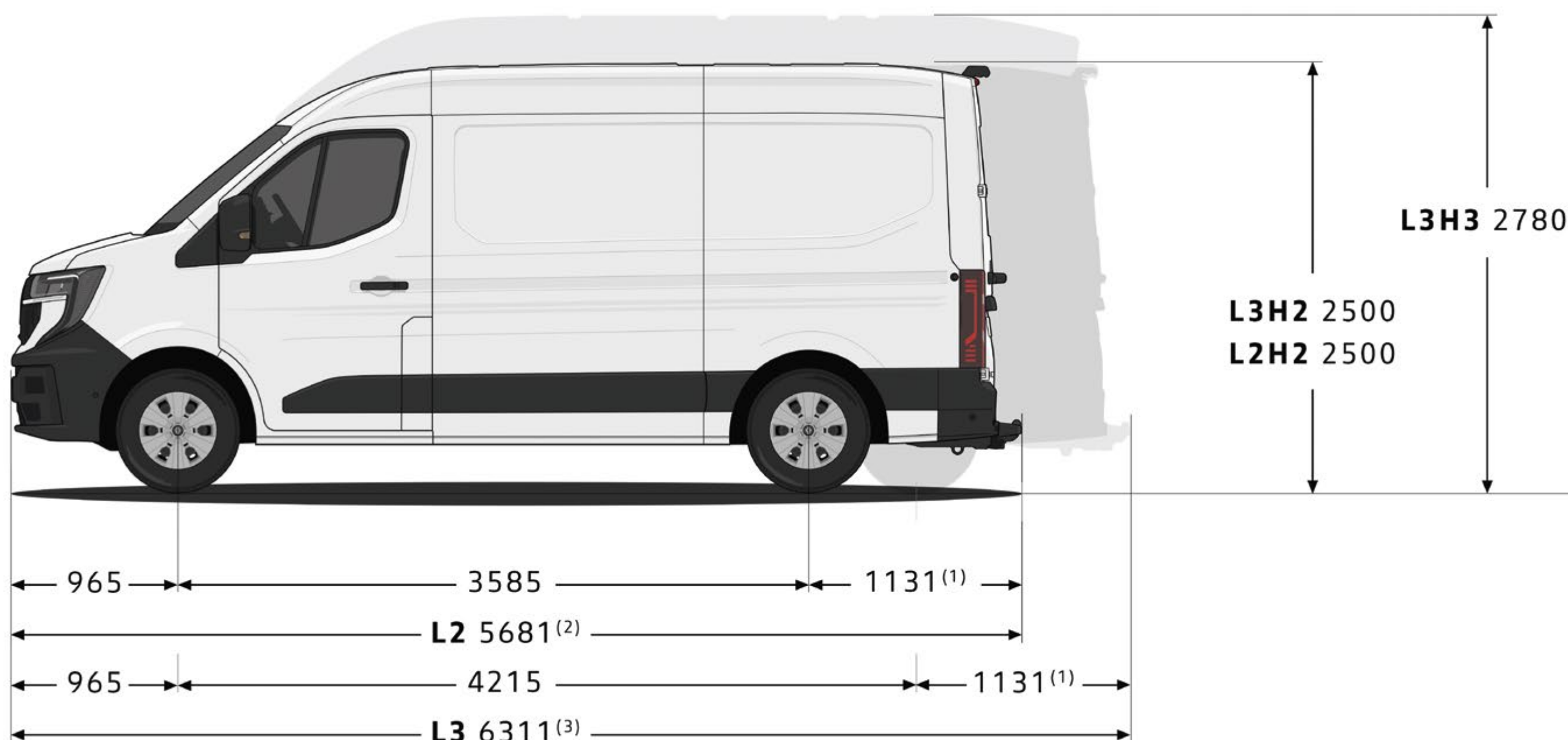

dimensions in (mm).



# Renault Pro+

**When you own a Renault van you become part of a team designed to keep your business moving. One that's been honing its expertise for more than 100 years. One that has awardwinning vehicles adapted to meet every business need. One called Renault Pro+.**

- . overnight servicing keeps your business moving  
4:00pm drop off 10:00am collection
- . price match guarantee  
subject to Pro+ Promise T&C's
- . dedicated experts at your service
- . 12 months parts and labour warranty - pride in our work

**Renault Pro+ Let's get to work**

**Find out more about Renault Pro+**



# Mobilize, services to make your life easier in electric vehicles

Enjoy a completely practical and efficient electric experience: installation of a charging point in your home as soon as you purchase the vehicle, support services delivered via your mobile.



**Mobilize power solutions**  
installation of home charging solutions.

**Mobilize charge pass**  
easier payment and location of charging points.

[find out more about Mobilize solutions](#)

## services dedicated to professionals in Pro+ centres

With its vast Pro+ network, Renault offers its professional customers innovative solutions in terms of products and services that are adapted to their needs.

**100% pro services**

- wide choice of internal combustion engine and electric light commercial vehicles
- custom conversions
- light commercial vehicle test drives
- extensive financing offers
- flexible maintenance contracts
- maintenance for all commercial vehicles and conversions

**mobility guaranteed**

- convenient workshop opening hours
- 24/7 key drop-off
- courtesy vehicle
- 24/7 breakdown recovery

**a partner for your business**

- dedicated Pro+ advisor
- advice to develop your business
- support for your energy transition

[find out more about Renault Pro+](#)





Every precaution has been taken to ensure that the contents of this brochure were accurate and up-to-date at the time of publication. This document has been created using pre-production and prototype models. In line with its policy of continuous product improvement, Renault reserves the right to modify the specifications, vehicles and accessories described and featured at any time. Any such modifications are communicated to Renault dealers as quickly as possible. Depending on the country of sale, versions may differ and some equipment may be unavailable (standard, optional or accessory). Please contact your nearest dealer for the latest information. For reasons to do with the medium, the colours featured in this document may differ slightly from those of the actual paintwork or interior trim. All rights reserved. Reproduction in any format and by any means of all or part of this brochure is prohibited without prior written authorisation from Renault.

Publicis - photo credits: P.McLean, Recom, © Renault Marketing 3D-Commerce - April 2025.  
Renault s.a.s, a French simplified joint stock company with a share capital of €533,941,113.00 / 122-122 bis avenue du Général Leclerc - 92100 Boulogne-Billancourt Cedex, France - registered on the Trade and Companies Registry (R.C.S.) of Nanterre under number B 780 129 987 / tel.: 0806 00 20 20.

# Renault Pro+

[business.renault.co.uk](https://business.renault.co.uk)



**build yours →**